

**A Review of Current Knowledge**

**Desalination for  
Water Supply**

**FR/R0013**

**First published February 2006**

**Second Edition May 2011**

**Third Edition June 2015**

**© Foundation for Water Research**

ARCHIVED

**This review is one of a series of Reviews Of Current Knowledge (ROCKs) produced by FWR. They focus on topics related to water supply, wastewater disposal and water environments, which may be the subject of debate and inquiry. The objective of each review is to produce concise, independent scientific and technical information on the subject to facilitate a wider understanding of the issues involved and to promote informed opinion about them.**

© Foundation for Water Research 2015

### **Copyright**

Apart from any fair dealing for the purposes of research or private study, or criticism or review, as permitted under the UK Copyright, Designs and Patents Act (1998), no part of this publication may be reproduced, stored or transmitted in any form or by any means, without the prior permission in writing of FWR.

### **Disclaimer**

Whilst every effort has been made to ensure accuracy FWR will not accept responsibility for any loss or damage suffered by any person acting or refraining from acting upon any material contained in this publication.

Appropriate professional advice should be sought when making important decisions to ensure the information is correct, up-to-date and applicable to specific circumstances.

### **Author**

R Clayton

# Review of Current Knowledge

---

## Desalination for Water Supply



Cover page image © Thames Water Utilities Ltd.

**Author: R Clayton**

# Review of Current Knowledge

---

## CONTENTS

	<b>Page</b>
<b>1 Introduction</b>	<b>3</b>
<b>2 What do we mean by “Desalination”?</b>	<b>10</b>
<b>3 How is the solids/salt content of brackish and sea waters reduced?</b>	<b>13</b>
<i>Thermal processes</i>	14
<i>Membrane processes</i>	15
<i>Other processes</i>	15
<i>Pre-treatment of feed water to desalination plants</i>	15
<i>Post-treatment of the produced desalination water</i>	17
<b>4 What is the range of concentrations to which different desalination processes can be applied?</b>	<b>17</b>
<b>5 How long has desalination technology been around ?</b>	<b>18</b>
<b>6 Thermal desalination</b>	<b>18</b>
Multi-stage flash evaporation/distillation (MSF)	19
Multiple-effect evaporation/distillation (MED)	20
Vapour compression distillation (VCD)	21
Solar desalination	22
Vacuum freeze desalination (VFD)	24
Secondary refrigerant freezing (SRF)	25
Clathrate or hydrate formaton process	26
<b>7 Membrane desalination</b>	<b>28</b>
Electrodialysis (ED/EDR)	28
Reverse osmosis (RO)	30
Forward osmosis (FO)	33
Membrane distillation	34
Rapid spray evaporation	35
Capacitive deionisation	35
Biometric membranes	36
<b>8 What is the cost of water produced by desalination?</b>	<b>37</b>
<b>9 Summary</b>	<b>40</b>
<b>Bibliography</b>	<b>42</b>
<b>Other useful sources of information</b>	<b>43</b>
<b>References</b>	<b>44</b>

# Review of Current Knowledge

---

## 1 Introduction

Without fresh water no society can function. Of all the water in the world a mere 0.5%-1% is fresh water available for the needs of all plant, animal and human life. Around 97% of the water in the world is in the oceans and approximately 2%-2.5% of the water is in ice stored in glaciers and in polar ice, although global warming is reducing this reservoir of fresh water (WBCSD, 2005).

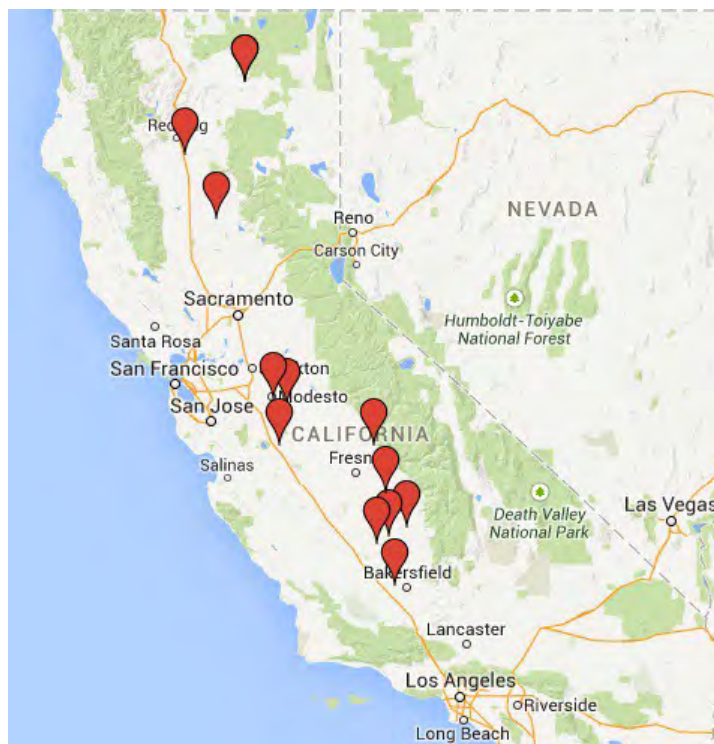
The over-exploitation of existing fresh water supplies is becoming a problem in many parts of the world. There are many causes, the principal ones being population growth, demands for higher living standards, growth of both agriculture and industry, and climate change. In Europe on average 24% of total water abstraction is used for agriculture, 11% for industry, 44% for energy production (mainly for cooling purposes) and 21% for public water supply (European Environment Agency, 2009).

Globally the main water consumption sectors are irrigation, urban, and manufacturing industry. Agriculture is a major user of water resources, especially in countries which already suffer from increasing water shortages such as Greece, Spain, Southern Europe in general and the Middle East and North African (MENA) countries. Water shortages and drought are already affecting countries round the world from Australia, China, Syria, Iraq, Sri Lanka to the USA and even parts of the UK. Already approximately 70% of the water abstracted around the world is used for irrigation (Vaknin, 2005) with this figure rising to over 80% in some countries (European Environment Agency, 2010); however, the Food and Agriculture Organization and the World Water Council have forecast that globally, water resources will be sufficient to produce the food required in 2050 although many regions will face substantial water scarcity (Food and Agriculture Organization, 2015).

In the United States water shortages are increasing across the majority of states and California has suffered serious droughts with a State of Emergency being declared in January 2014 with approximately 77% of the state under “extreme drought” or “exceptional drought” conditions (United States Government Accountability Office, 2014). In March 2015 the Governor of California imposed mandatory water use reductions for the first time in California’s history, saying the state’s four-year drought had reached near-crisis proportions (New York Times, 2015).

## Review of Current Knowledge

---



**Figure 1: Map showing areas in California where wells are running dry, 2014-15**

In Australia concerns have been expressed over water supplies and the salination (i.e. intrusion of seawater) of existing fresh-water sources because of over-exploitation (Winter et al., 2000). Australia suffered a 12-year drought which finished with widespread floods in 2012 but there are continuing concerns over the long-term outlook which could be affected by climate change (Corum, 2014). The situation in Australia is being resolved partly by an increase in rainfall but particularly by the installation of desalination plants; in the period 2013-2014 seventeen new plants were contracted, six of which treated seawater and another five brackish inland water (IDA<sup>1</sup>, 2014). Large seawater desalination plants in Australia now supply 15% of the city's total demand in Sydney, 30% in Melbourne and 50% in Adelaide, Brisbane and Perth (Palmer, 2014).

The situation in some parts of the world is so severe that the possibility of conflict between neighbouring states is becoming a real possibility (Vaknin, 2005; McLoughlin, 2004; BBC, 2000).

---

<sup>1</sup> IDA is the International Desalination Association, <http://idadesal.org/>

## Review of Current Knowledge

---

Water availability is already under stress in many parts of the world including the UK. This stress is defined by the value of the Water Exploitation Index, the WEI, developed by the European Environment Agency (Environment Agency and Natural Resources Wales, 2013). The WEI is explained in the box on this page. The warning threshold for water stress is when the WEI=20% at which level the region may be considered to be stressed; severe water stress can occur when the WEI is greater than 40% which indicates strong competition for water (European Environment Agency, 2003).

Water shortages are forecast to increase, especially in urban areas where the demand for water is growing. Even in the UK potential problems with shortages in the water supply are starting to appear. For example, much of the South East of England is now formally defined by the Environment Agency as being under Water Stress. The following English water supply companies are now classified as being under serious stress (Environment Agency and Natural Resources Wales, 2013):

- Affinity Water
- Anglian Water
- Essex & Suffolk Water
- South East Water
- Southern Water
- Sutton & East Surrey Water
- Thames Water

### ***The Water Exploitation Index.***

*The water exploitation index (WEI) is defined as the mean annual total abstraction of fresh water divided by the available long-term average freshwater resources. It describes how the total water abstraction puts pressure on water resources. It identifies countries which abstract a high proportion of the available water and which are thus at risk of suffering problems of water stress.*

*The long-term average freshwater resource is derived from the long-term average precipitation minus the long-term average evapotranspiration plus the long-term average inflow from neighbouring countries.*

$$WEI = \text{totABS} / \text{LTAA} \times 100$$

*Where: totABS = total annual freshwater abstraction for all uses; LTAA = long term annual average of total freshwater resources, where data are averaged over a period of at least 20 consecutive years.*

*The warning WEI level is generally accepted as 20%, which distinguishes a non-stressed region from a stressed one. Severe water stress can occur for WEI>40%.*

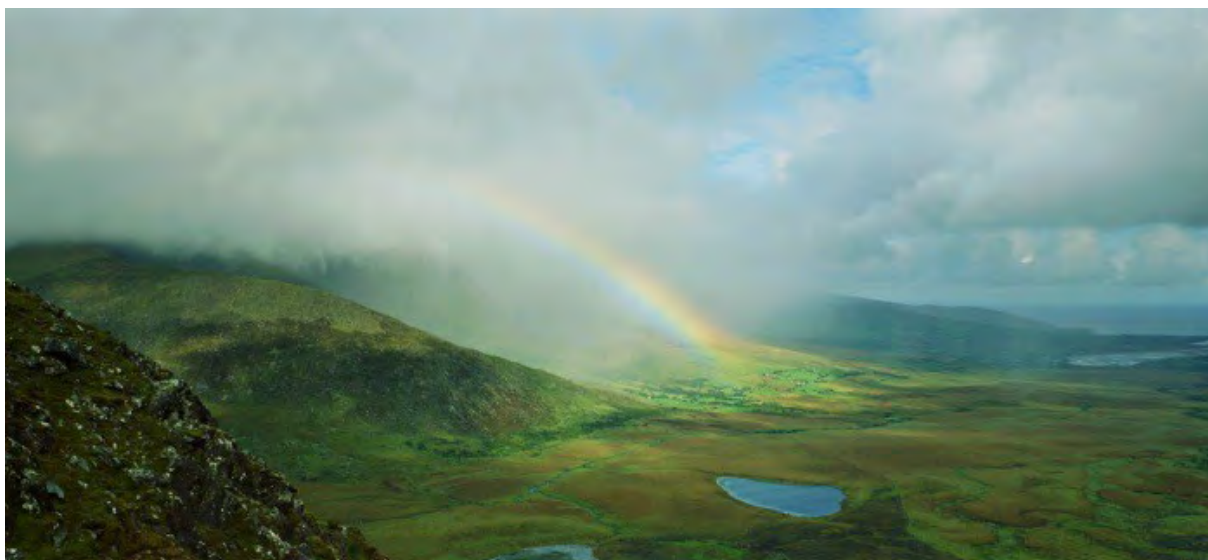
## Review of Current Knowledge

---

The Thames basin is one of the most intensively used water resource systems in the world and Thames Water (which is one of the companies which supplies London) is already using about 55% of rainfall of which 82% is for public water supply (Thames Water, 2014). In 2010 Thames Water opened the first desalination plant in the UK for the supply of drinking water.

It has been estimated that, by the 2020s, without some action nearly half of water resource zones in England could be at risk of deficit during a drought due to the combined effect of climate change and population growth by 2020 (Krebs, 2012). Neither Wales nor Scotland are at risk of water stress; Northern Ireland, together with Ireland, has one of the world's lowest Water Exploitation Indices.

Table 1 shows some of the countries with some of the world's worst WEI in which the recycling rate for water is as high as 20-fold. Countries with an excess supply of water available for exploitation can have a WEI as low as 0.77. The UK as a whole is well below the 20% level at which water stress may start although, as pointed out on the previous page, there are areas in England in which the water stress is classed as serious.



**Rainbow over a watery landscape in Ireland.**

Photograph: Ron Bambridge/Getty Images/OJO Images RF

## Review of Current Knowledge

---

**Table 1: The countries with the world's worst and best Water Exploitation Index**

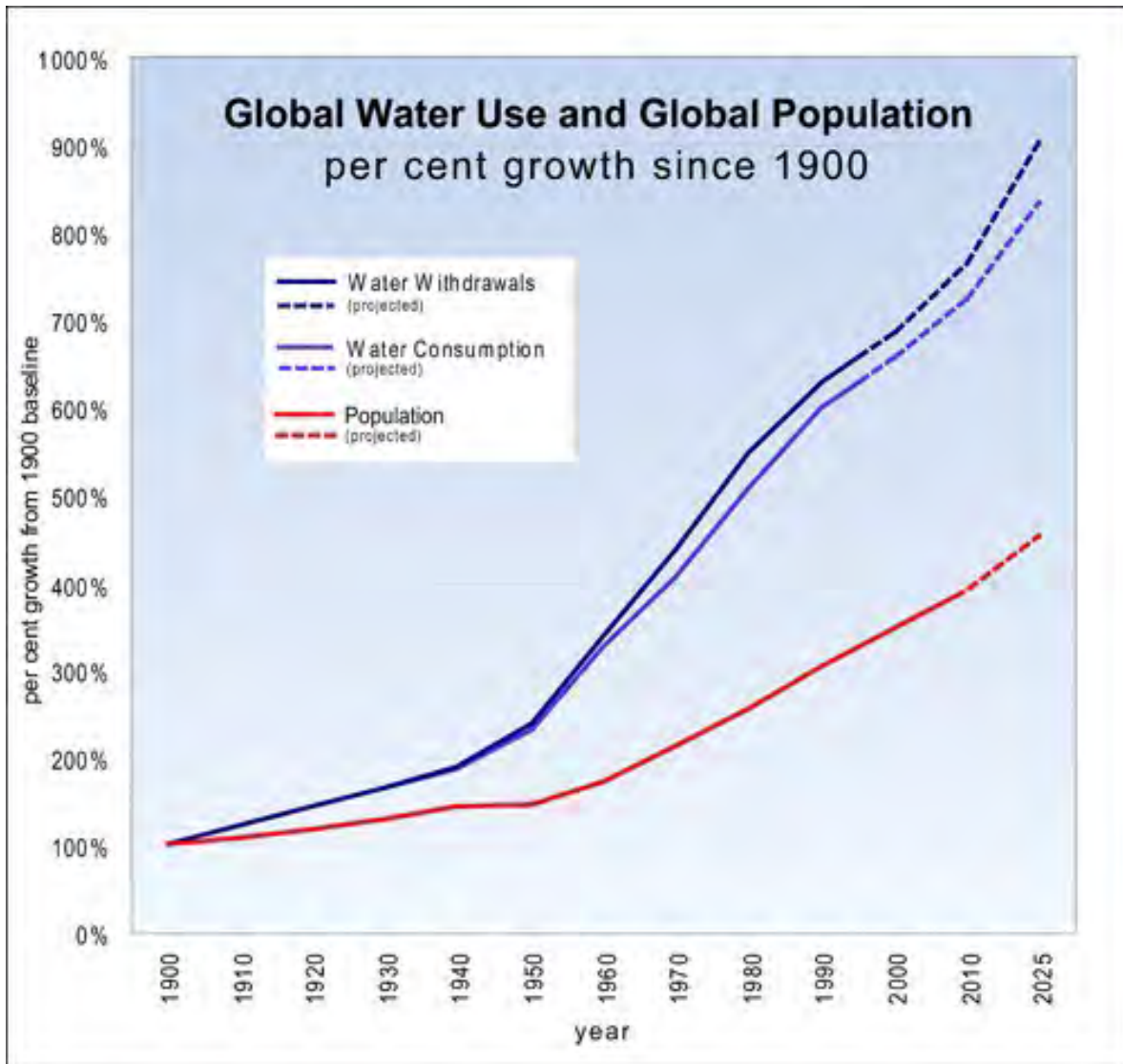
<b>Countries with the fewest resources</b>	m <sup>3</sup> /person per year	% withdrawn
Kuwait	6.9	2,075
United Arab Emirates	18.5	1,867
Saudi Arabia	83.6	936
Jordan	145	99.4
<b>Countries with the most resources</b>		
Canada	83,691	1.5
Norway	77,016	0.77
Russia	34,590	1.47
Finland	20,359	1.49
Sweden	18,325	1.5
Latvia	15,861	1.18
Ireland	11,356	1.5
UK	2,332	8.8

Locke Bogart & Schultz (2004) point out that the areas of greatest potential water shortages tend to be regions with high population density, or high wealth density, or both. Clearly desert regions such as those in North Africa, Western Australia and Central China are also regions with water shortages. This situation is made worse by the fact that many water resources are shared by two or more countries. According to UNESCO there are currently 263 river basins which are shared by two or more countries supporting roughly 40% of the global population. In the majority of cases, the institutional arrangements needed to ensure the fair use of water resource are weak or non-existent (UNESCO, 2003). Although UNESCO has been working on this problem, for example by establishing the International Centre for Water Security and Sustainable Management, the problem persists. The Water Footprint Network<sup>2</sup> was founded in 2008 to promote the sharing of water fairly. The problem has also been examined by Hoekstra (2008) in the context of globalisation.

---

<sup>2</sup> <http://waterfootprint.org>

## Review of Current Knowledge



**Figure 2: The demand for water has grown twice as fast as population**

Although climate change is certainly a factor, population growth and the demand for a higher standard of living are undoubtedly the main cause of the growth in water shortages as the graph shows in Figure 2 (UNEP, 2012). The consequence of this is a rise in the Water Exploitation Index in a number of countries to unacceptably high levels as shown in Table 1.

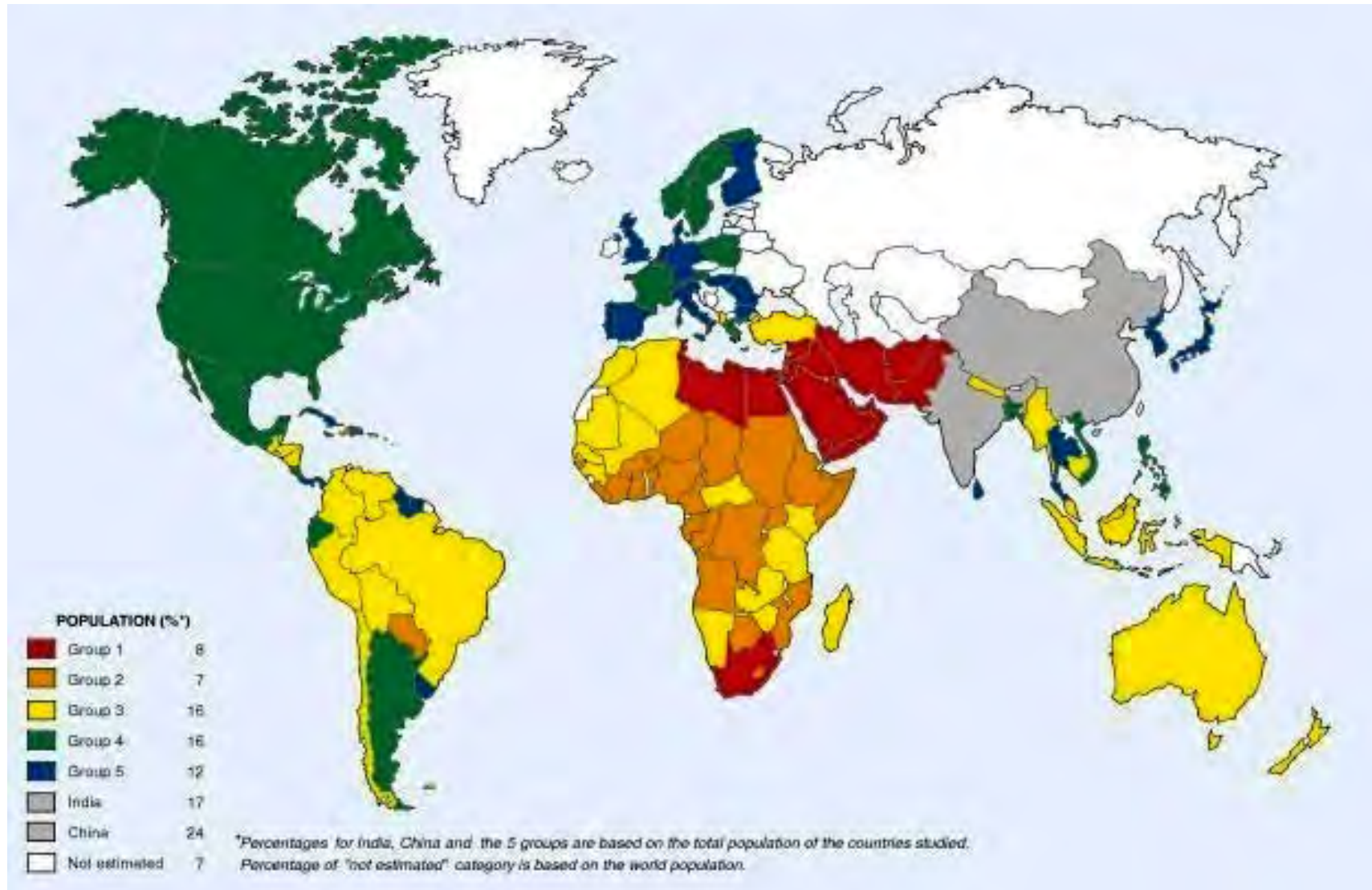


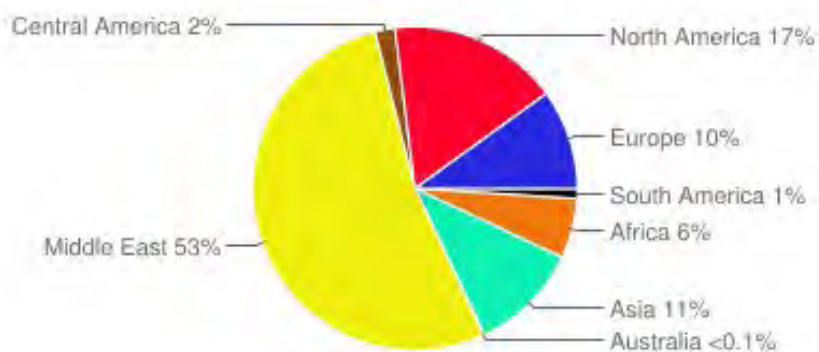
Figure 3: The IWMI global map of water scarcity (Seckler et al., 1998). Red areas are those with greatest scarcity.

## Review of Current Knowledge

---

There is a number of ways in which this problem of increasing water shortage can be tackled such as the more economical use of water by reduction in wastage; the increased recycling of water by both industrial and domestic users; by the transfer of water from areas rich in water resources to areas of need - for example, the proposed use of a pipeline from Turkey to Israel<sup>3</sup> and the use of canals and rivers in the UK to transfer water from one area to another (DEFRA, 2000), for example the use of the Cotswold Canals as a route for water to be pumped from the River Severn to the River Thames (Thames Water, 2014); and by the reduction in the salt content of brackish and sea water to turn them into a drinkable supply, a process called "*desalination*" which is the subject of this ROCK.

There are, approximately, over 23,000 desalination plants in more than 150 countries treating over 85,000 m<sup>3</sup>/d with over half of them in the Middle East (see Figure 4 ), and the number is continuously growing - in 2013-14 about 564 new plants were contracted (IDA, 2014).



**Figure 4: World desalination plants per geographical area (%).**  
(Adapted from Zotalis, 2014).

## 2 What do we mean by "Desalination?"

Desalination refers to those processes which reduce the quantity of dissolved substances in the water fed to the process. We all know that sea water tastes excessively salty and that in normal circumstances it cannot be drunk or used for normal domestic purposes such as washing and cooking. However, if this salt content could be reduced it would then be possible to produce a water suitable for drinking and other domestic purposes.

---

<sup>3</sup> The project was cancelled by Turkey in 2010 after nine Turkish activists were killed in a raid by Israeli forces on a Turkish ship carrying aid to the Gaza Strip; this shows how political water can be. In fact, Israel no longer has water shortages as a result of investment in seawater desalination projects (Haaretz, 2014).

## Review of Current Knowledge

---

All naturally occurring water, even rain, contains substances dissolved in it. These substances will include salts such as sodium chloride, calcium bicarbonate, magnesium sulphate and a range of other naturally occurring substances. These substances contribute to the flavour of water; water which has no dissolved substances in it tastes "flat" and unpleasant. Equally, if the concentration of dissolved substances is too high, as in sea water for example, the water tastes unpleasant. For normal drinking water supplies there has to be a balance between these two extremes. The classification of water according to the quantity of dissolved substances in it is shown in Table 2 (National Research Council, 2004); Table 3 shows the palatability of water with different concentrations of dissolved solids expressed as milligrams per litre (mg/l) which is the same as ppm i.e. parts per million (WHO, 1984).

Some seas and evaporative lakes can show wide variability in total dissolved solids, for example, the Persian Gulf has an average Total Dissolved Solids (TDS) of 48,000 mg/l and Mono Lake in California has a TDS of 100,000 mg/l. (National Research Council, 2004). The salinity of the Dead Sea reaches 250,000 mg/litre, a level approximately seven times as high as that of the ocean, whereas the surface salinity of the Arctic Ocean (ie the top 50m) can be as low as 20,000 mg/l (Johnson & Polyakov 2001).

**Table 2: The classification of water according to its concentration of solids.**

Description	Dissolved solids (mg/l)
Drinking water	less than 1,000
Mildly brackish	1,000 to 5,000
Moderately brackish	5,000 to 15,000
Heavily brackish	15,000 to 35,000
Average seawater	35,000

## Review of Current Knowledge

---

**Table 3: The palatability of water according to its concentration of total dissolved solids.**

Palatability	Dissolved solids (mg/l)
Excellent	less than 300
Good	300 to 600
Fair	600 to 900
Poor	900 to 1,200
Unacceptable	more than 1,200

In the UK the Water Supply (Water Quality) Regulations 2000 do not specify a total dissolved solids concentration for drinking water but instead specify a maximum conductivity of 2,500 microSiemens at 20°C as a measure which corresponds roughly to about 1,200 mg/l of dissolved solids. The classification of water according to its quantity of dissolved solids is shown in Table 2 (National Research Council, 2004). The World Health Organisation recommends not more than 1,000 mg/l for drinking water (WHO, 2006).

## Review of Current Knowledge

---

Water produced by desalination processes may be used in its pure form (e.g., for make-up water in power plant boilers) or it may be mixed with water containing some dissolved solids and used for drinking water, irrigation, or other uses (see Figure 6).

Desalinated water is usually purer than the standards specified for drinking water, so if the water is intended for municipal use, it may be mixed with water that contains higher levels of total dissolved solids. Pure desalinated water is highly acidic and is thus corrosive so it has to be given additional treatment to adjust the pH and hardness before being pumped to supply.

Desalinated water which is supplied as drinking water must conform to statutory requirements for drinking water quality which, in the case of England & Wales, are the Water Supply (Water Quality) Regulations (2000), and in Scotland, The Water Supply (Water Quality) (Scotland) Regulations (2001).

### *Taste or Flavour in water.*

*The Threshold Flavour Number (TFN) is the dilution ratio beyond which the diluted sample does not have a perceptible flavour.*

$$TFN = A + B$$

*Where:*

*A is the volume of a sample*

*B is the volume of reference water used for the dilution*

*Thus (A + B) is the total volume of sample with no perceptible flavour.*

*The Dilution Number (DN) is defined as:*

*DN = sample volume/volume of the diluting water*

*A sample which has no taste has a TFN of 1 and a Dilution Number of 0.*

*The Water Supply (Water Quality) Regulations 2000 specify a dilution number of 3 at 25°C which is equivalent to a threshold number of 4.*

*The taste of water with a Total Dissolved Solids concentration of about 750 mg/l and above is generally considered to be poor.*

*However, sensitivity to flavour in drinking water can vary between individuals by a factor of a few thousand, so the only effective way of evaluating taste is with specialist panels of tasters.*

### **3 How is the solids/salt content of brackish and sea waters reduced?**

When the arctic and antarctic seas freeze over in winter the ice which forms on the surface is essentially fresh water. The act of freezing expels the salts in the sea water and melting this ice will produce fresh water; this gives us one way in which fresh water can be produced from sea-water, a technique known as Freeze Desalination (UKAEA, 1967). This process requires the use of heat-energy (which is first removed to form ice and then added to melt the ice) and is one of a group of processes termed Thermal Desalination.

## Review of Current Knowledge

---

All desalination processes use chemical engineering technology in which a stream of saline water is fed to the process equipment, energy in the form of heat, water pressure or electricity is applied, and two outlet streams are produced; a stream of desalinated (fresh) water and a stream of concentrated brine which must be disposed of. This is shown in Figure 5 below.



**Figure 5: Basic principle of desalination.**

There are two main groups of processes which can be used to reduce the concentration of dissolved solids in brackish or sea water; Thermal Processes and Membrane Processes.

### *Thermal Processes*

The simplest example of a thermal process is distillation in which the heat is used to generate steam from the sea water which is then condensed to form water with a low salinity which can be used for domestic and industrial purposes or for irrigation. There are three main desalination techniques which use the principle of distillation: and a couple of methods which have still to be proved on a commercial scale:

- Multi-stage flash evaporation/distillation (MSF)
- Multiple-effect evaporation/distillation (MED) also known as long-tube vertical distillation (LTV)
- Vapour compression distillation (VCD)
- Solar distillation
- Rapid spray evaporation.

A number of additional thermal process have also been proposed but have not yet been exploited commercially:

- Membrane distillation
- Vapour reheat flash distillation

## Review of Current Knowledge

---

There are three thermal processes which use thermal energy to freeze and then melt the ice formed in the freezing stage:

- Vacuum freezing
- Secondary refrigerant freezing
- Clathrate or hydrate formation process

### *Membrane Processes*

There are four membrane processes in current use:

- Reverse Osmosis (RO)
- Electrodialysis (ED or EDR)
- Electro-Deionisation (EDI)
- Forward Osmosis (FO)

### *Other processes*

Other processes which may be considered for desalination of water include:

- Solar distillation
- Ion exchange
- Capacitive deionisation.

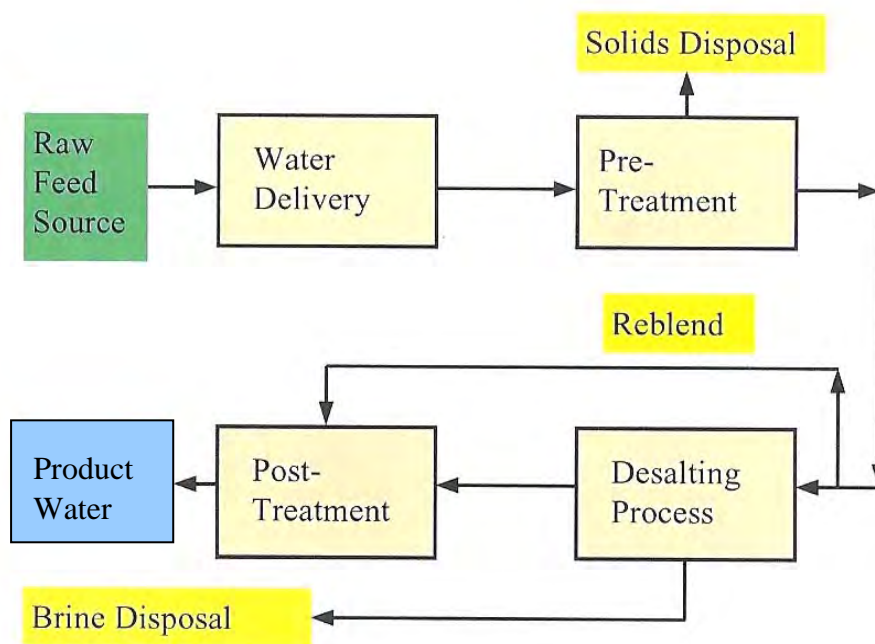
The worldwide installed capacity for the different processes is shown in Figure 7.

### *Pre-treatment of feed water to desalination plants.*

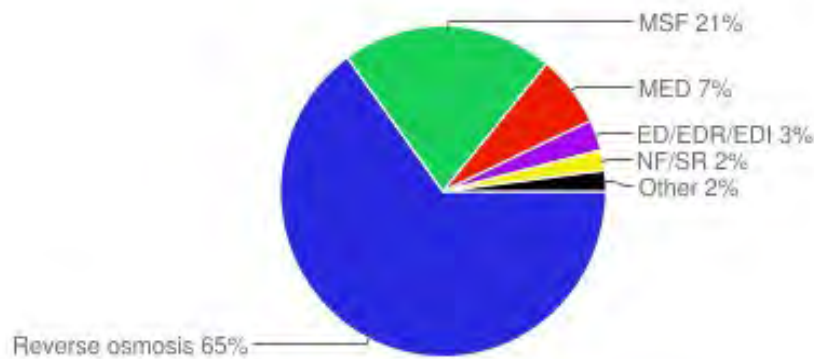
The water fed to a desalination plant will generally contain other impurities in addition to dissolved solids such as silt, algae, bacteria and other forms of small plant and animal life. A particularly important form of impurity are the so-called Transparent Exopolymer Particles (or TEP) which were only identified fairly recently (Alldredge et al., 1993). TEP are formed from dissolved polymers exuded by phytoplankton and bacteria and are found in the sea and fresh water in concentrations of 28 to 5000 particles per millilitre and vary in size from 2-200 micro-metres (i.e. 0.002 to 0.2 millimetres) and exist in many different forms from amorphous blobs, clouds, sheets, filaments or clumps and sometimes recognisable as debris from broken plankton (Berman and Holenberg, 2005). TEP can be an important source of nutrition for micro-organisms including bacteria.

## Review of Current Knowledge

These impurities, and particularly TEP, can have an adverse effect on desalination processes by fouling surfaces and membranes. This can be particularly serious in the case of RO by allowing biofilms (i.e. films of bacteria) to develop on the surfaces of membranes resulting in a reduction of the flowrates (or flux rates). This can reduce the effective life of the membranes and cause an increase in operating costs. It is therefore necessary to include a pre-treatment stage in desalination plants as shown in Figure 6 below. Pre-treatment will typically consist of some form of filtration (e.g. granular or pre-coat filtration), for example by using some form of coagulation process to cause particulate impurities especially TEP to agglomerate thus making removal by filtration more effective.



**Figure 6: Simplified flow-sheet of the complete desalination process.**



**Figure 7: Worldwide installed desalination capacity for the different processes (IDA, 2014)**

## Review of Current Knowledge

---

### *Post-treatment of the Produced Desalinated Water.*

Thermal desalination processes produce water with a very low dissolved content, in effect, they produce distilled water. As noted above, water devoid of dissolved substances tastes "flat" and unpleasant, so if the water is to be used for drinking purposes some dissolved solids and air must be added back to the desalinated water. As shown in Figure 6, this is usually done by blending a proportion of the feed water with the desalinated water, aerating the water and adding some chemicals to reduce its corrosivity. Also, disinfection will be required before the water can be put into the water mains supply network. This final treatment is shown in Figure 6 as "post treatment".

Membrane processes reduce the salt content of water but do not reduce it to the low levels achieved by distillation processes so re-blending of the product water with the higher-salinity feed-water is generally not required, although some form of post-treatment may still be necessary such as re-aeration and corrosion control and, of course, disinfection.

#### **4 What is the range of concentrations to which different desalination processes can be applied?**

Sea water has an average concentration of dissolved solids of 35,000 mg/l (3.5%), but this can vary quite considerably as shown in Table 4 below.

**Table 4: Variation of seawater salinity.**

Sea	Approximate Salinity in mg/l
Red Sea	40,000
Mediterranean Sea	38,000
Average seawater	35,000
Black Sea	18,000
Baltic Sea	8,000

The range of concentration of dissolved solids in the water to which different processes can be applied economically are shown in Table 5 below.

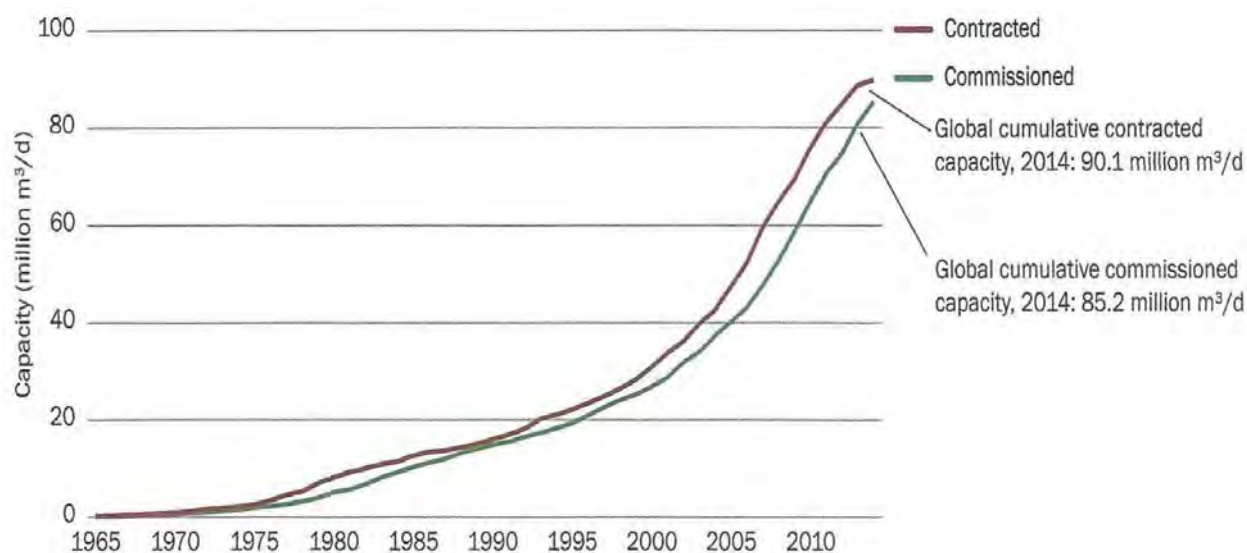
**Table 5: Range of concentrations to which different desalination processes can be applied.**

Process	Concentration Range in mg/litre
Ion exchange	10 - 800
Reverse Osmosis	50 - 50,000
Electrodialysis	200 - 10,000
Distillation processes	20,000 - 100,000

# Review of Current Knowledge

## 5 How long has desalination technology been around?

Collecting dew to provide drinking water is probably as old as mankind, and the ancient Greeks are said to have used evaporation from sea water to obtain drinking water. It is claimed that the first desalination plant in America was turning seawater into drinking water at Fort Zachary Taylor in Key West, Florida as early as 1861 (Ehrenman, 2004), but the use of modern technology for desalination probably dates from the beginning of the last century. In 1914 the first desalination plant in Kuwait was commissioned. A single-stage flash distillation plant was installed on HMS *Vanguard* in 1945, and throughout the 1950s and 1960s a large number of desalination plants, mainly thermal, were installed around the world for both irrigation and drinking water supply, mainly by British companies, (UKAEA, 1967). The first Electrodialysis (ED) desalination plants were installed by William Boby & Co. in 1963 in Libya using technology licensed from TNO<sup>4</sup> in the Netherlands. Although Reverse Osmosis had been recognised as a potential technology for desalination in the early 1960s and a few RO desalination plants had been constructed in the late 1960s it was many years (approximately in the 1980s) before membranes of sufficient quality and appropriate cost had been developed to permit RO to start competing with thermal processes.



**Figure 8: Global cumulative installed and commissioned desalination capacity 1965-2014 (IDA, 2014)**

<sup>4</sup> TNO The Dutch Organisation for Applied Scientific Research.

## Review of Current Knowledge

---

**Table 6: The eight largest desalination plants in the world (as at May 2015).**

Location	Capacity (m <sup>3</sup> /d)	Feedwater	Operation year	Process
Ras Al-Khair, Saudi Arabia	1,025,000	Seawater	2013	MSF/RO
Shuaiba, Saudi Arabia	880,000	Seawater	2007	MSF
Al Jubail, Saudi Arabia	800,000	Seawater	2007	MED
Jebel Ali, United Arab Emirates	636,440	Seawater	2007	MSF
Sorek, Israel	627,000	Seawater	2015*	RO
Jebel Ali, United Arabic Emirates	600,000	Seawater	2011	MSF
Al Zour North, Kuwait	567,000	Seawater	2007	MED
Magtaa,. Algeria	500,000	Seawater	2009	RO

\*The Sorek plant began operating in 2013 at a reduced output.

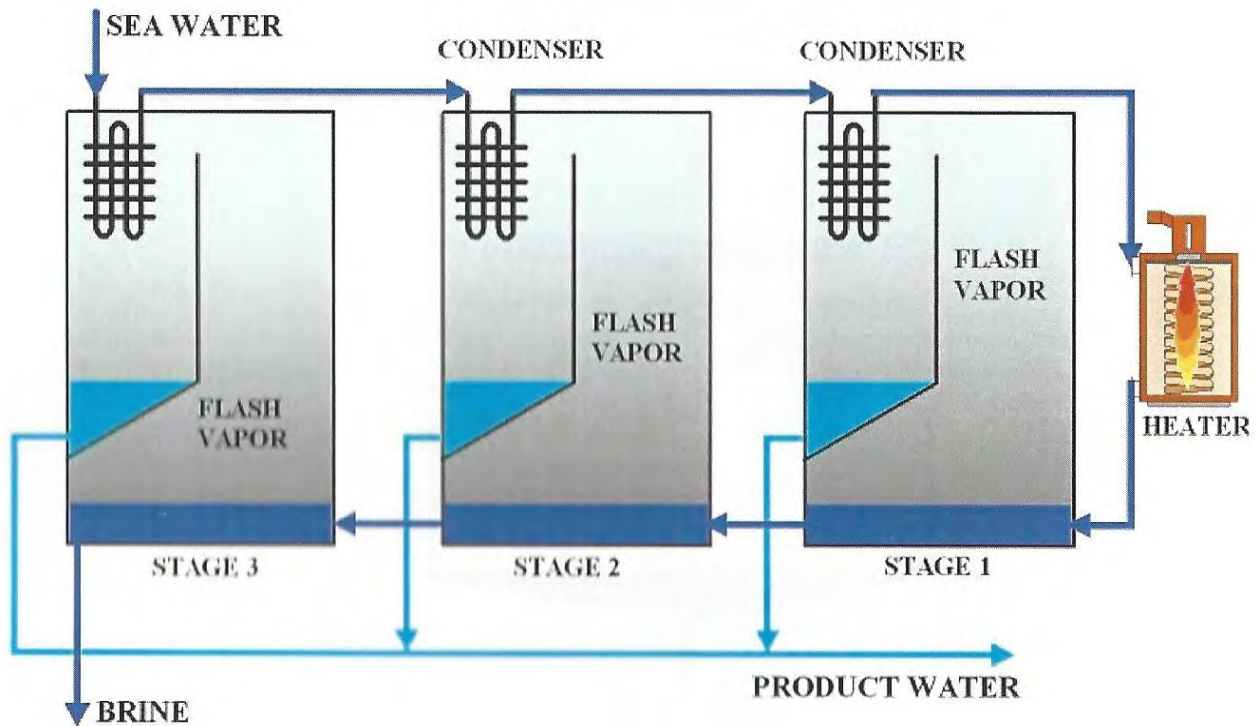
## 6 Thermal desalination

### *Multi-stage flash evaporation/distillation (MSF)*

In multi-stage flash evaporation the saline (sea or brackish) water is heated and evaporated; the pure water is then obtained by condensing the vapour. When the water is heated in a vessel both the temperature and pressure increase; the heated water passes to another chamber at a lower pressure which causes vapour to be formed; the vapour is led off and condensed to pure water using the cold sea water which feeds the first heating stage. The concentrated brine is then passed to a second chamber at a still lower pressure and more water evaporates and the vapour is condensed as before. The process is repeated through a series of vessels or chambers until atmospheric pressure is reached. Typically, an MSF plant can contain from 4 to about 40 stages.

This principle is illustrated in Figure 9 which shows just three stages; in commercial plant many more stages are used.

## Review of Current Knowledge



**Figure 9: Diagram of the multi-stage flash evaporation desalination process.**

Multi-stage flash evaporation is considered to be the most reliable, and is probably the most widely used, of the three principal distillation processes.

### ***Multiple-effect evaporation/distillation (MED)***

Multiple-effect distillation<sup>5</sup> (MED) is also known as long-tube vertical distillation (LTV) and is in principle similar to multi-stage flash evaporation, except that steam is used to heat up the seawater in the first stage and the resulting vapour is used in subsequent stages to evaporate the water, and the seawater/brine is used to cool and condense the vapour in each successive stage so that the temperature gradually falls across each stage of the process. As in the case of multi-stage flash evaporation, many stages are used in commercial plants. The diagram in Figure 10 shows the principle of MED.

<sup>5</sup> The multiple-effect evaporator was invented by Norbert Rillieux in the early 1800s who built the first industrially practical evaporator in 1845. The process was originally developed for concentrating sugar in sugar cane juice but is now more widely used for salt production and water desalination.

# Review of Current Knowledge

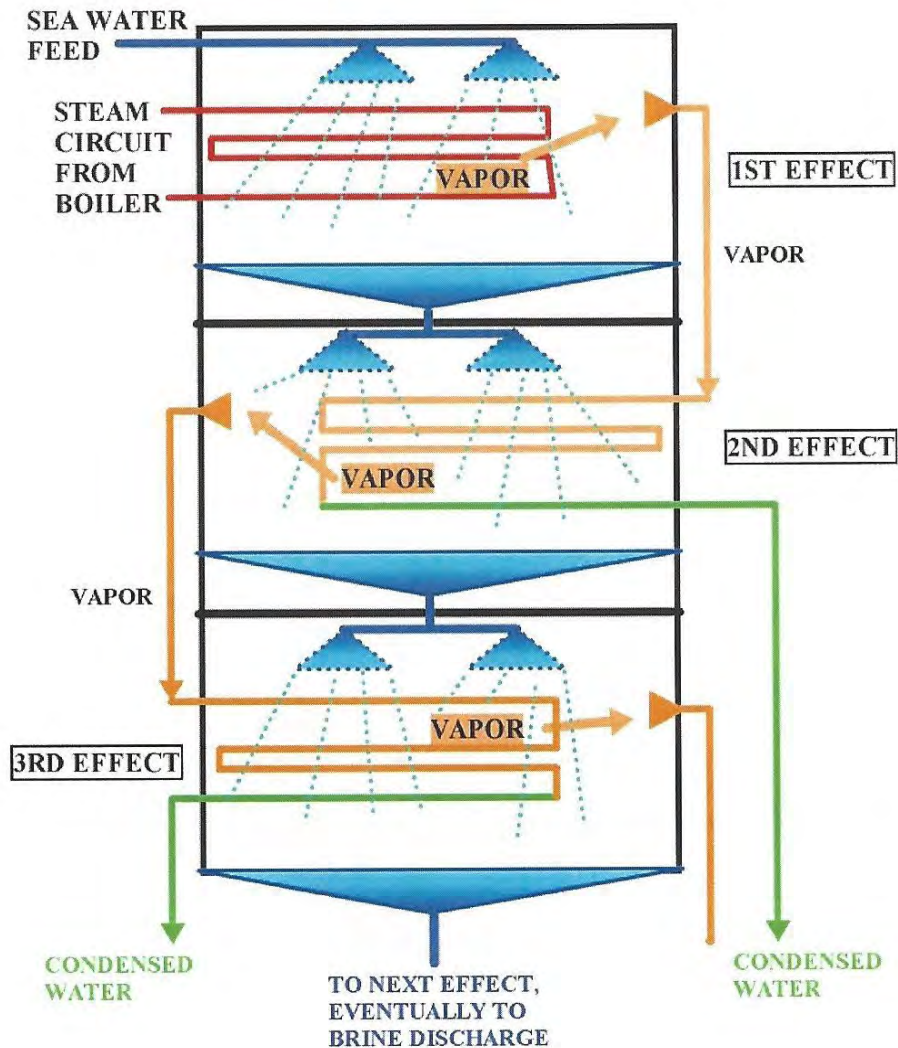


Figure 10: Diagram of a horizontal MED desalination plant.

## Vapour Compression Distillation (VCD)

Steam is generated from the seawater using a source of heat and the vapour is then compressed using a compressor. As a result of this compression the temperature and pressure of the steam is increased ie the work done in compressing the vapour is changed into heat<sup>6</sup> (you notice this effect when pumping up a bicycle tyre and the pump warms up). The incoming seawater is used to cool the compressed steam which then condenses into distilled (fresh) water and at the same time the seawater is heated further producing more steam. This is shown in Figure 11.

<sup>6</sup> Conservation of energy requires that the amount of work done in developing the heat must be equal to the amount of heat energy it produced. The proportionality between these two energy units is called the Joules Constant.

## Review of Current Knowledge

Vapour compression distillation is usually used where the requirement for desalinated fresh water is relatively small such as on small communities, ships or in holiday resorts. In Australia in 2002 VCD was the second most commonly used process for desalination after reverse osmosis accounting for about 18% of Australia's national desalination capacity (URS Australia, 2002).

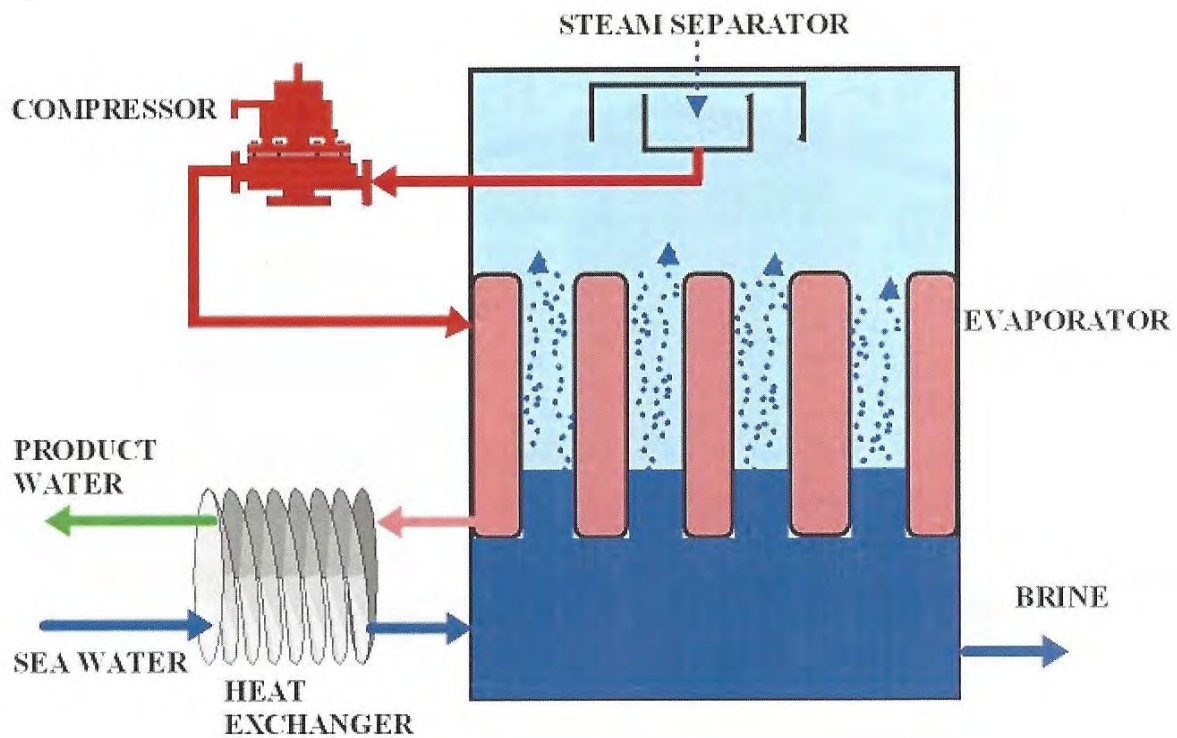


Figure 11: Diagram of Vapour Phase Compression desalination.

### *Solar distillation*

Solar distillation has been around for many years and is simple technology suitable only for small outputs. Heat from the sun warms the seawater in a glass-covered tank causing some to evaporate. The vapour is condensed on a glass cover and the resultant fresh water is collected as shown in the diagram in Figure 12. This is a cheap low-cost system, the main costs arising from the pumping of the seawater and the fresh water condensate, but is not suitable for large-scale production of water. Problems can arise from the growth of algae on the underside of the glass cover, and good sealing is required otherwise the vapour and heat can escape reducing the effectiveness of the system.

## Review of Current Knowledge

A well-maintained solar still produces about 8 litres for every square metre of glass, so the area required for about 4 people would be 130-260 square metres. An Australian development of this system which is reliable and effective uses pipes, but in 2002 was prohibitively expensive (URS, 2002).

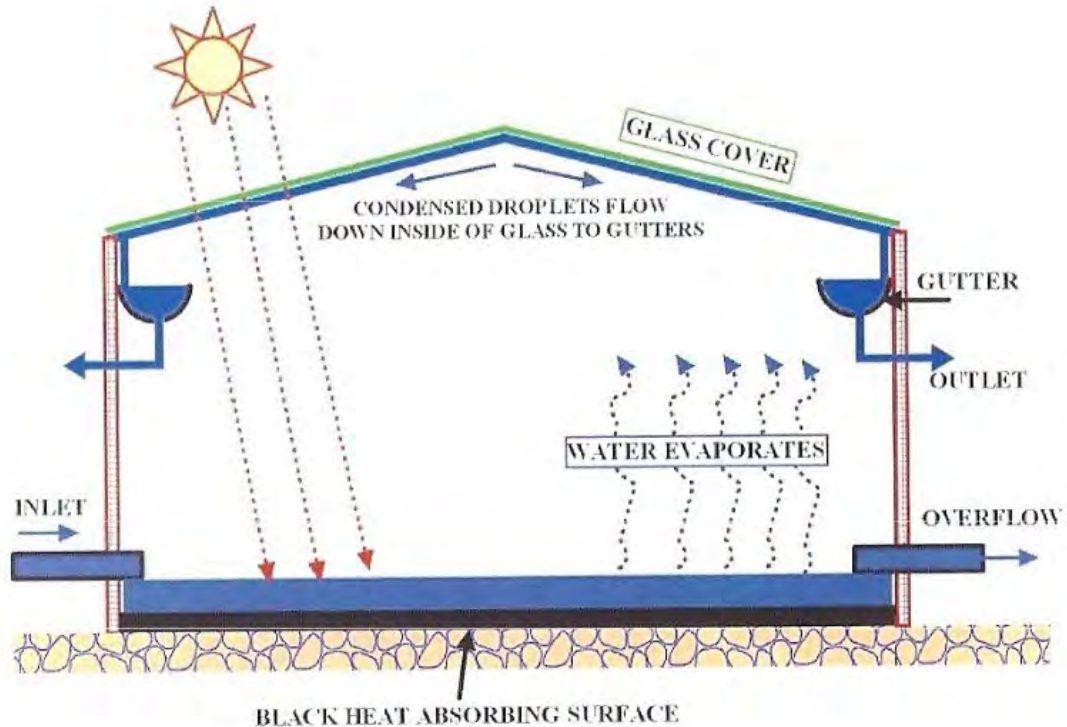


Figure 12: Diagram of a solar distillation system.

However, a more recent and detailed study has concluded that solar stills built on this principle but carefully designed can be relatively inexpensive and effective (Torchia-Núñez et al., 2014). A diagram of their system is shown in Figure 13 below.

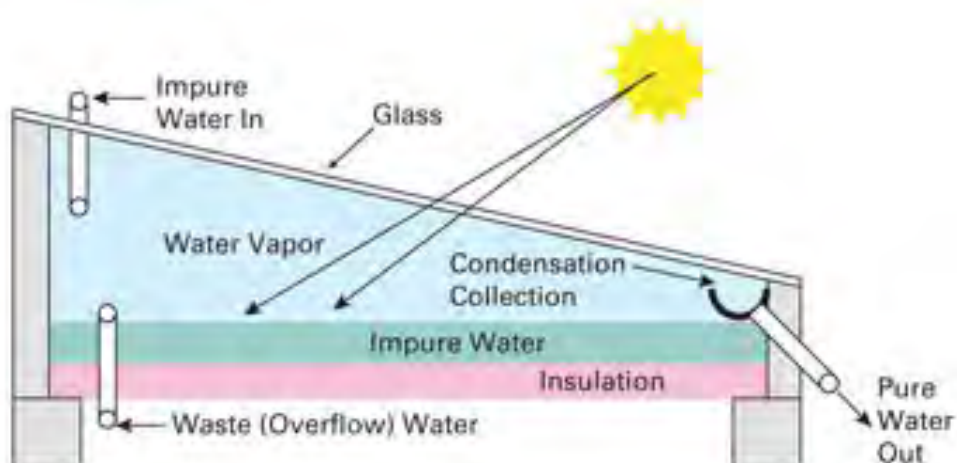


Figure 13: A simple cheap solar still.

## Review of Current Knowledge

---

In recent years, there has been considerable development in large-scale solar systems for power generation, both thermal and photovoltaic. Thermal power stations offer an opportunity for solar desalination but, despite extensive R&D in Australia, the USA, Chile and Spain, where a pilot plant produced 72 m<sup>3</sup>/day, (Blanco et al., 2008), there are no large-scale plants yet in operation. However, it was announced in early 2015 that Saudi Arabia is planning a full-scale desalination plant using RO powered by solar energy. Concern over global warming has generated considerable interest in the use of solar energy (now frequently referred to as concentrated solar power or CSP) for desalination processes, either directly, as in the case of solar distillation, or using humidification (Qu, 2009). In recent years there has been rapid growth in the use of solar energy in desalination generally, for example the use of photovoltaic cells to generate electricity for RO plants (Williams, 2013) and in the use of solar energy for the so-called multiple-effect humidification (MEH) process. Some small MEH units have been installed in and near Jeddah, Saudi Arabia, which successfully produce 5m<sup>3</sup>/day and 10m<sup>3</sup>/day of desalinated water. However, MEH will only be useful for the production of relatively small quantities of water. In January 2015 work began in Saudi Arabia on the world's largest solar powered desalination plant using photovoltaic cells and Reverse Osmosis. The plant should be completed by early 2017 and will supply 60,000m<sup>3</sup>/day of desalinated seawater to the city of Al Khafji (Parkinson, 2015).

### *Vacuum freeze desalination (VFD)*

As noted above, when water freezes the salts dissolved in the water are excluded from the ice which is formed. Cooled saline water is sprayed into a vacuum chamber at a pressure of about 0.004 atmospheres (i.e. 0.4 KPa or 3mm Mercury). Some of the water flashes off as vapour removing more heat from the water causing ice to form. The ice floats on the brine and is washed with fresh water, melted and the fresh water (which is less dense than the brine) flows out of the washer-melter as shown in the diagram in Figure 14 (UKAEA, 1967). In theory, freeze desalination has a lower energy requirement than other thermal processes and little susceptibility to the scaling problems which can affect distillation processes. Although a few small plants have been built in the last 40 years the process has not yet been commercially developed (URS, 2002). At present no commercial plant is available for the desalination of seawater (Rahman & Al-Khusaibi, 2014) by this process.

## Review of Current Knowledge

---

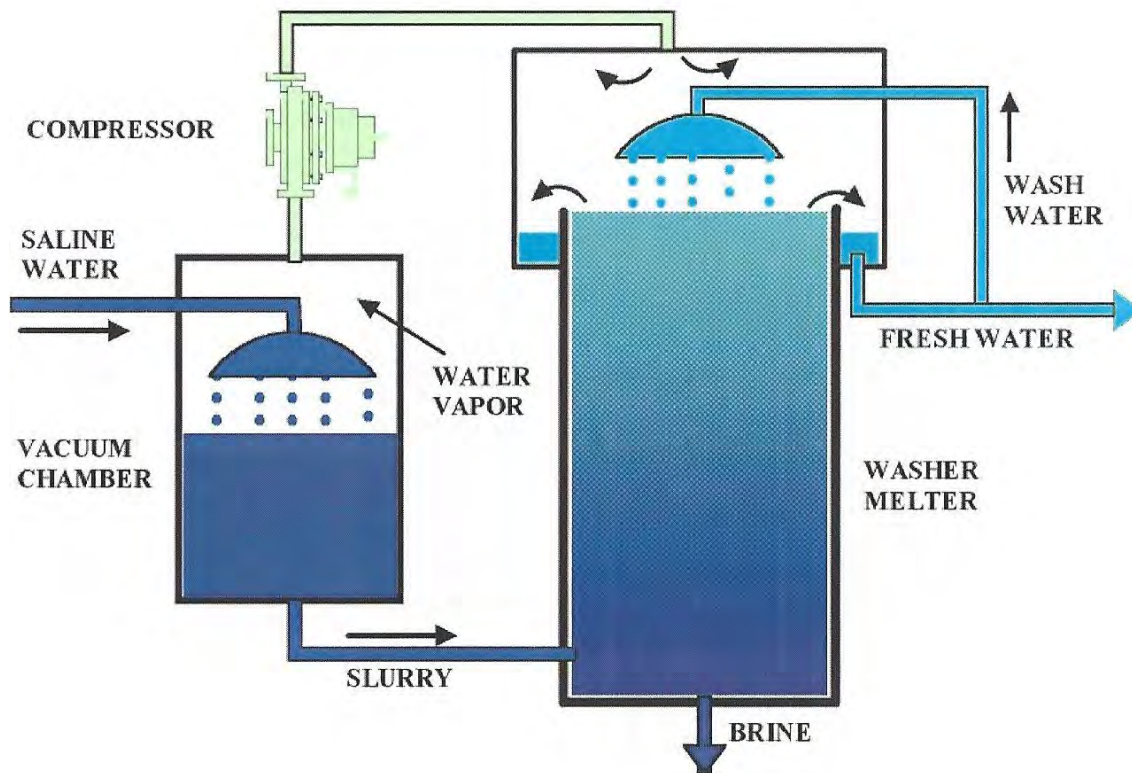


Figure 14: Vacuum freeze desalination.

### *Secondary refrigerant freezing (SRF)*

In this variant of freeze desalination a liquid hydrocarbon refrigerant such as butane, which will not mix with water, is vaporised when in direct contact with the saline water thus producing a slurry of ice in brine. The vaporised refrigerant is taken off, compressed and cooled in the melter and recycled to the freezer/crystalliser, and the slurry of ice is taken off, washed and passed to the melter. The advantage claimed for secondary refrigerant freeze desalination is an even lower energy requirement than for freeze desalination, and low susceptibility to scaling and corrosion. The process is shown in the diagram in Figure 15. A pilot plant treating 56m<sup>3</sup>/day operated successfully in the United States (Ganiaris et al., 1969), but as far as can be established was never commercialised for drinking water.

## Review of Current Knowledge

---

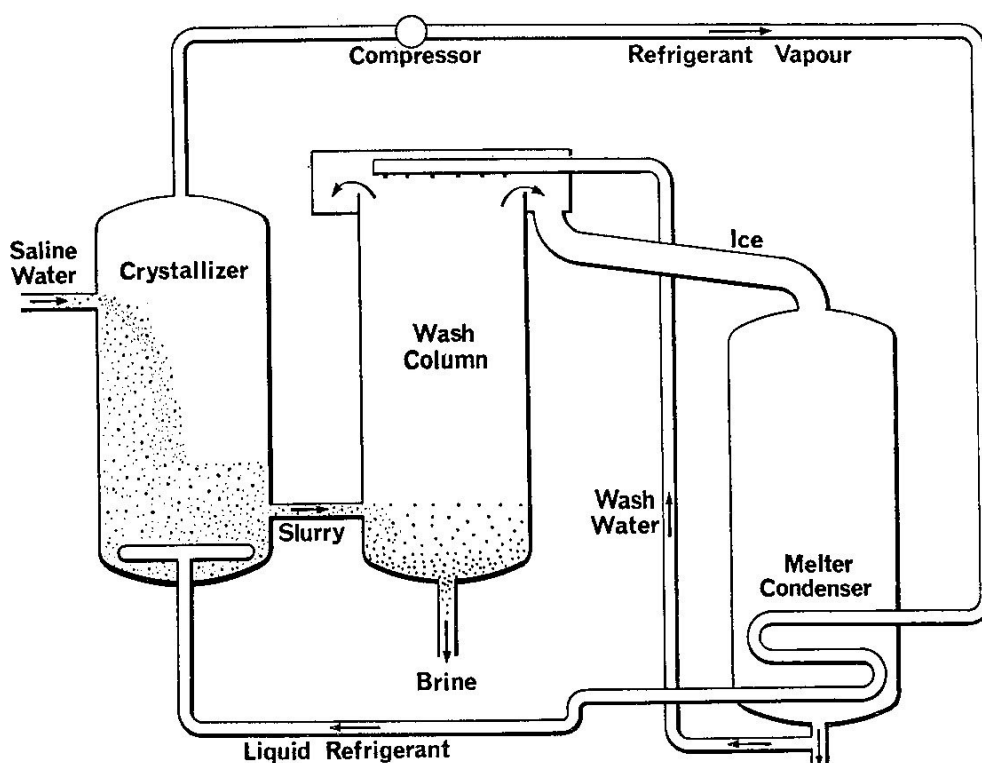


Figure 15: Secondary refrigerant freeze desalination (UKAEA, 1967).

The SRF process was considered by the Water Resources Board as a possible method for supplementing water supplies in England and Wales in the 1970s (Water Resources Board, 1972), but despite some development work it never achieved commercialisation. The Dutch also considered the process (Schippers, 1979).

### *Clathrate or hydrate formation process*

In this process the saline water is mixed with a hydrocarbon which forms hydrates or clathrates. In a clathrate a hydrocarbon molecule is enclosed in a molecular "cage" of water molecules forming a solid ice-like phase as shown in Figure 16 which shows a methane ( $\text{CH}_4$ ) molecule held in a "cage" of water ( $\text{H}_2\text{O}$ ) molecules by Van der Waals forces<sup>7</sup> (Corfield, 2002).

---

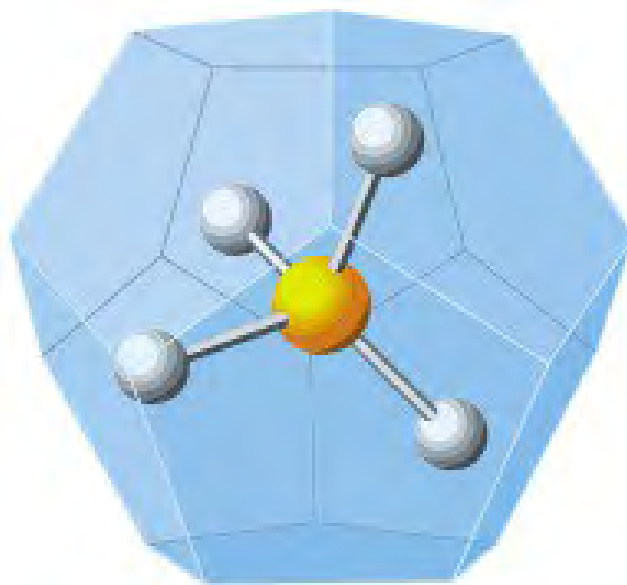
<sup>7</sup> Van der Waals forces are weak inter-molecular forces arising from the electrical charges on molecules. Normally a small molecule consisting only of three small atoms like water ( $\text{H}_2\text{O}$  or  $\text{H-O-H}$ ) would be a gas, but the attractive forces between water molecules hold them together thus creating a liquid at normal temperatures and pressures.

## Review of Current Knowledge

---

The "cage" or hydrate forms ice-like crystals which contain none of the salts present in the seawater in which the hydrate forms. The crystals can be warmed in order to release water molecules; clathrates could be used in cold deep seawater to "entrap" water molecules and then warmed at shallower depths to release the water which would contain no dissolved salts.

A range of hydrocarbons such as methane, ethane and butane all have the ability to form clathrates at temperatures in the range of approximately 0°C to 15°C. For industrial desalination applications the preferred chemical would be a refrigerant such as a hydrofluorocarbon which will form a clathrate (hydrate) at temperatures above 0°C at which ice forms. The crystals of hydrate are separated from the brine and melted to release the refrigerant and water free of salts. Although in theory this process has an efficient use of energy and should be able to compete with other desalination processes, the crystals formed have tended to be small and difficult to separate satisfactorily from the brine (McCormack & Andersen, 1995). No full-scale commercial plants have yet been constructed for this process



**Figure 16: A methane (CH<sub>4</sub>) molecule in a "cage" of water (H<sub>2</sub>O) molecules.**

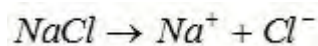
Extensive research is being undertaken on the use of clathrate compounds for the desalination of seawater but so far no pilot plants have been built and there is no commercialisation of the technology but it continues to offer interesting possibilities (Max, 2005, 2009).

# Review of Current Knowledge

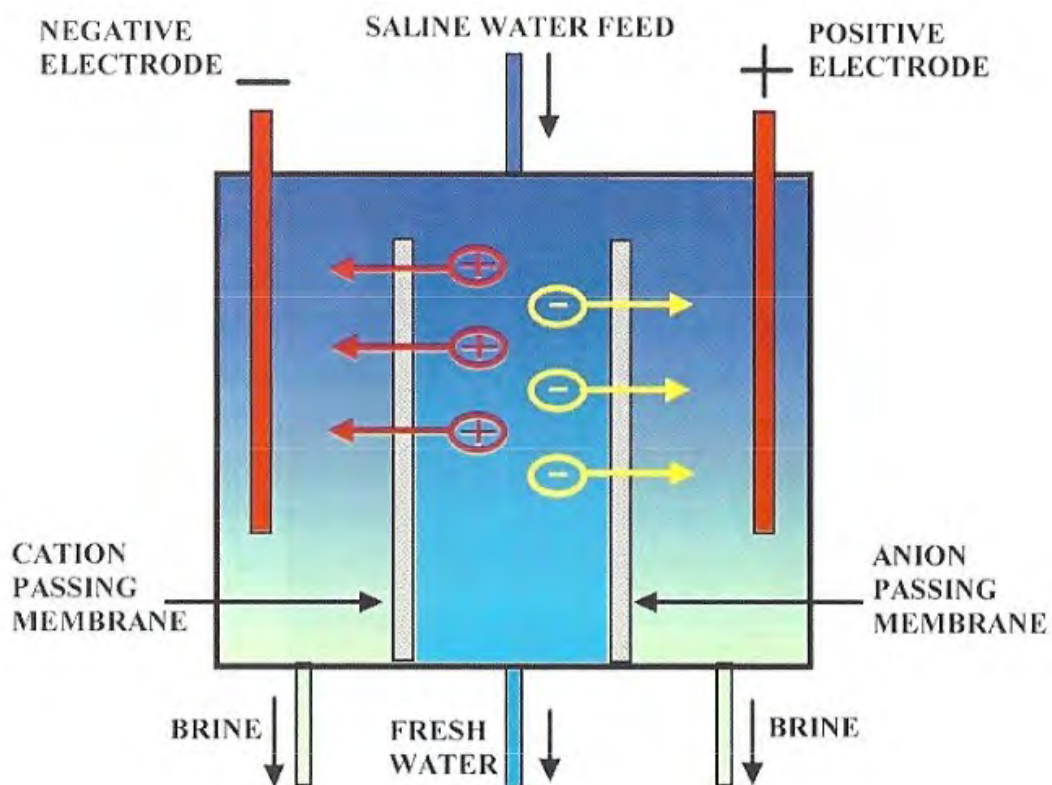
## 7 Membrane desalination

### *Electrodialysis (ED/EDR)*

Electrodialysis uses a stack of ion-exchange membranes which are selective to positive and negative ions. The salts in seawater are composed of positive and negative ions so, for example, common salt (which is sodium chloride, NaCl) dissolves in water to produce positively charged sodium ions and negatively charged chloride ions thus:-



Under the influence of a direct (or DC) electrical current the positive sodium ions pass through a cation membrane and the negative chloride ions pass through an anion membrane as shown in Figure 17 below.



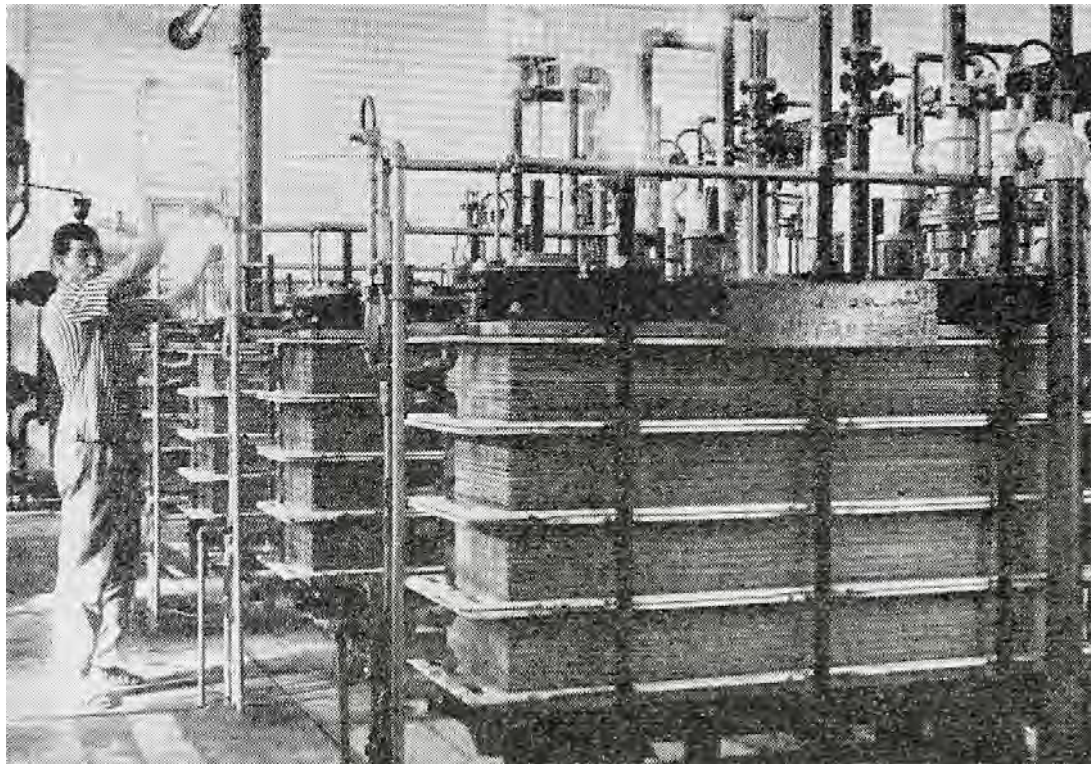
**Figure 17: Diagram of an electrodesalination cell showing how positive and negative ions are removed from a saline feedwater via ion exchange membranes by means of an electrical current.**

## Review of Current Knowledge

---

The incoming saline water is thus converted into two streams, one of concentrated brine and one of desalinated (fresh) water. Industrial electro dialysis plants consist of stacks of hundreds of membranes. Fouling of the ion exchange membranes can occur and this can be partly overcome by reversing the direction of the DC current; this process is known as electro dialysis reversal or EDR.

Electrodialysis was the first membrane desalination process to achieve commercial success. One of the first commercial units in the world was installed in Tobruk in Libya in 1959 by the British Company William Boby Ltd using membranes developed and manufactured in the Netherlands by TNO. The plant, which had an output was 55 m<sup>3</sup>/day, was so successful technically and economically that a second unit with a capacity of 450 m<sup>3</sup>/day was ordered at the end of 1959 although this was subsequently transferred to the town of Zliten (see photo in Figure 18) when water was piped to Tobruk from an abundant but much more expensive source.



**Figure 18: The 450 m<sup>3</sup>/day Electro dialysis plant at Zliten in Libya.**

Electrodialysis is still used today but has been overtaken by Reverse Osmosis as the preferred membrane desalination process.

## Review of Current Knowledge

---

### *Reverse osmosis (RO)*

Osmosis is the process in which water passes through a semi-permeable membrane from a low-concentration solution into a high-concentration solution. It is a process which occurs in plant and animal tissue including the human body (e.g. the secretion and absorption of water in the small intestine). If a pressure is applied to the high-concentration side of the membrane the reverse process occurs, namely water diffuses through the semi-permeable membrane from the high-concentration solution into the low-concentration solution, i.e. reverse osmosis. This is shown in the diagram in Figure 19.

Seawater is pumped under pressure across the surface of the membrane, water molecules diffuse through the membrane leaving a concentrated brine solution on the feed-side of the membrane and fresh water on the low-pressure product side. The brine solution is rejected as wastewater and is typically between 10% and 50% of the feed water depending on the salinity and pressure of the feed water.

Reverse osmosis membranes are manufactured from modern plastic materials in either sheets or hollow fibres. In a modern RO plant the membranes are put together in modules which can be linked together according to the size of plant required. Modern RO plants use four alternative configurations of membrane, namely tubular, flat sheets (called plate & frame), spiral-wound and the hollow fibre configuration. Examples of spiral-wound and hollow fibre systems are shown in Figure 20. Membranes manufactured from ceramic materials have been investigated but have not yet been exploited commercially for desalination.

# Review of Current Knowledge

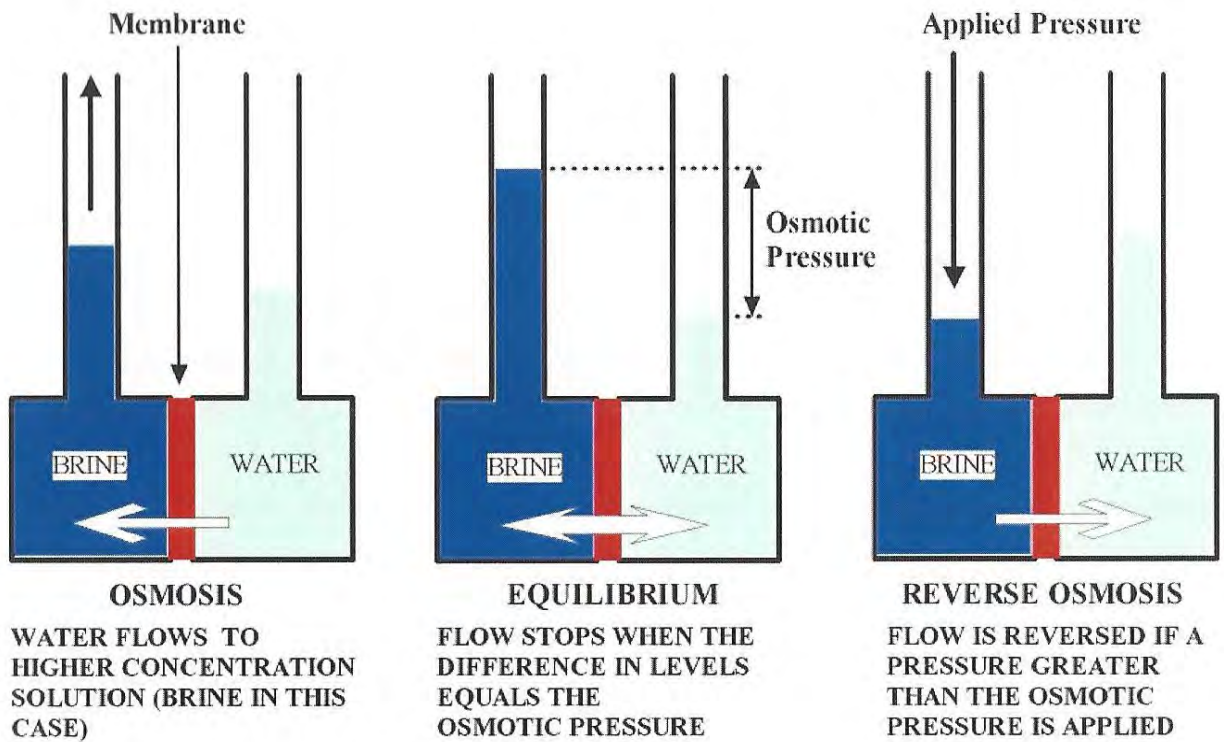


Figure 19: Diagram showing the principle of Osmosis and Reverse Osmosis (semi-permeable membrane shown in red).

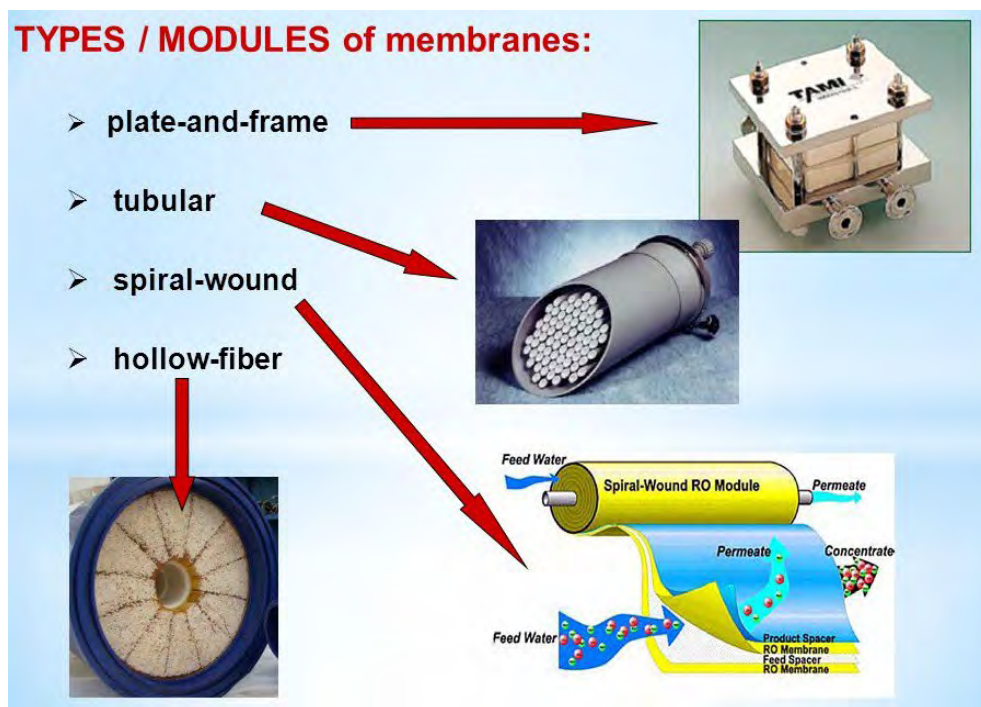


Figure 20: The different types of membrane configuration for RO systems.

## Review of Current Knowledge

---

RO plants vary from small domestic units for use either in the home (see Figure 21 below) or on small ships to large industrial and municipal units for supplying communities with a potable water supply. The largest RO desalination plant in the world has been built at Sorek in Israel. The plant was finished in late 2013 but only began producing at its full capacity of 627,000m<sup>3</sup>/day January 2015 (Talbot, 2015). The plant will be part of a network of large-scale RO seawater desalination plants along the mediterranean coast of Israel which have eliminated problems of water shortages in the country; 40% of Israel's water is now produced by desalination.



**Figure 21: A small domestic RO unit.**



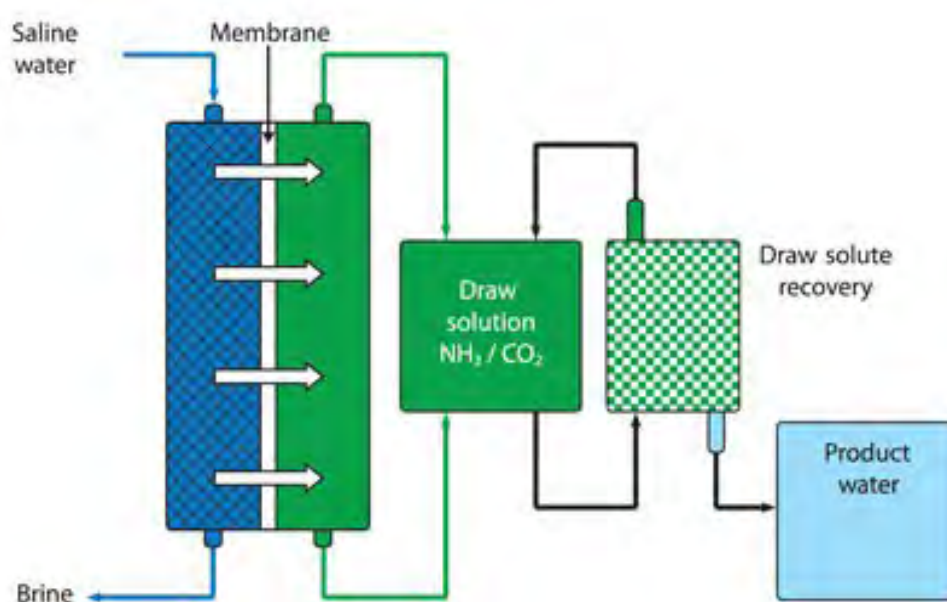
**Figure 22: RO modules in a large desalination plant.**

## Review of Current Knowledge

Membranes are subject to contamination, especially biofouling, arising from suspended particles and micro-organisms in the feed water. A particular problem is caused by the Transparent Exopolymer Particles (TEP) discussed in the section on pretreatment above, so pre-treatment is an essential part of any RO desalination plant.

### *Forward osmosis (FO)*

Forward osmosis is an emerging technology which is slowly gaining ground in the desalination market. As in RO, it uses a membrane, but on the “desalinated” side of the membrane it uses what is termed a “draw solution” into which water is drawn from the salty seawater or brackish water. The “draw solution” contains a solution of larger molecules (the “draw chemical”) which inhibit the rate of flow of water molecules back into the salt solution so that there is a net flow of water from the salty water to the “draw solution”. The “draw solution” is then passed through a recovery system which separates the draw chemical from the water; the desalinated water passes out of the recovery stage for subsequent use, and the draw chemical is recycled. In the diagram in Figure 23 the draw chemical is ammonium carbonate which can be removed from the water by heating the solution which drives off the ammonium carbonate as ammonia gas and carbon dioxide gas leaving pure water behind. The gases are recovered and recycled (McCutcheon et al., 2005). A range of other chemicals have also been tried including nanoparticles which are cheap and relatively easy to recover (McCutcheon & Bui 2014).



**Figure 23: Diagram of the Forward Osmosis process (Crow , 2012)**

## Review of Current Knowledge

---

It is possible to draw water through a membrane from brine using a sugar solution on the other side of the membrane so that normal or forward osmosis occurs thus diluting the sugar solution but leaving the salt on the other side of the membrane. The sugar solution can then be drunk. This is the method used by the army and in natural disasters when drinking water supply is a problem.

The world's first FO plant treating seawater to produce drinking water was installed in Oman and began producing 200m<sup>3</sup>/day in 2012<sup>8</sup>. Other FO plants have been installed in the USA to treat heavily brackish produced-water from gas-fields with TDS concentrations of up 125,000 mg/l; the plants produced water of drinking quality<sup>9</sup>.

### *Membrane distillation.*

Membrane distillation (MD) is a thermal, membrane-based separation process which uses the vapor pressure difference across the membrane produced by a temperature difference. MD was investigated in the late 1960s but was not commercialised at that time for desalination because of the unavailability of suitable membranes and its relatively high cost. With the availability of new types of membrane in the 1980s research was again undertaken on membrane distillation and many novel MD modules were designed based on a better understanding of the mass and heat transfer principles of MD (Camacho et al., 2013). The development of ceramic membranes have made it possible to use higher temperatures which may, in the future, make it possible to develop larger plants than have been manufactured so far. Advantages of the process include lower temperatures than the conventional thermal processes and lower pressures than conventional membrane processes.

Practical applications of the process are still being developed but some plants have been installed for the production of drinking water. The systems are still very small and are aimed at small communities but are able to produce water at an economical cost. Typical packaged plants produce water in the range of 50-1,000 litres/hour. The world's first MD desalination unit utilizing the waste heat from the local power generator to produce up to 10,000 litres of drinking water per day began operating early in 2014 on the small island of Gulhi in the Maldives. The island is home to about 1200 inhabitants (Aquaver<sup>10</sup>, 2014). A number of small units have also been supplied by a German company<sup>11</sup>. A detailed technical evaluation of MD has been published by Yang et al. (2014) and a very comprehensive review by Camacho et al. (2013).

---

<sup>8</sup> The plant was designed and built by the British company Modern Water plc, based in Guildford

<sup>9</sup> The plants were designed and built by Oasys Water, Inc., based in Boston.

<sup>10</sup> Aquaver BV, Het Sterrenbeeld 23, 5215 MK's Hertogenbosch, The Netherlands

<sup>11</sup> Solar Spring GmbH, Hanferstr. 28, 79108 Freiburg, Germany

## Review of Current Knowledge

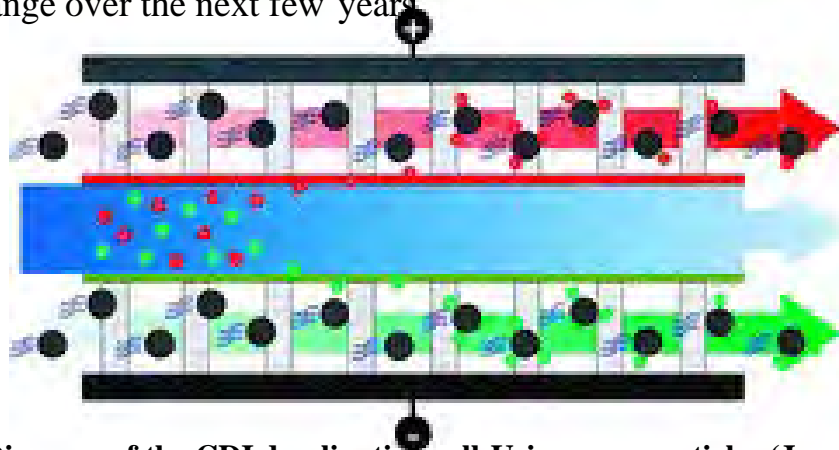
---

### *Rapid spray evaporation.*

This technique involves spraying droplets of salty water into a chamber where they evaporate rapidly causing the dissolved salts to fall to the bottom of the chamber. The vapour leaves the chamber and is condensed to pure water (Ellis, 2003). Although the technique looks promising and has been evaluated it appears that, apart from a demonstration unit, no plants have been built.

### *Capacitive deionisation.*

Capacitive deionisation (CDI) is a variant of Electrodialysis which operates by adsorbing the ions of the TDS in solution in the double-layer formed at the electrodes when an electrical current flows. The process is sometimes termed “Electro-sorption”. CDI can be used to treat brackish water with a TDS in the range 800-10,000 mg/l. It has a lower energy consumption than RO and ED, and can be used in conjunction with ED to desalinate seawater (Lee & Moon, 2014). The benefits of the technique is that it uses no chemicals, no membranes and has a low power consumption. Unfortunately, it requires a discharge stage to remove the retained ions and this has limited its application. However, some recent research in Korea has found a clever way to overcome this limitation using a suspension of active carbon nanoparticles with membranes thus opening the way to wider applications on a larger scale (Jeon et al., 2013); the new technique achieved a 95% reduction of TDS in a salt solution of 32,100 mg/l. Although only small units are available commercially this may change over the next few years.



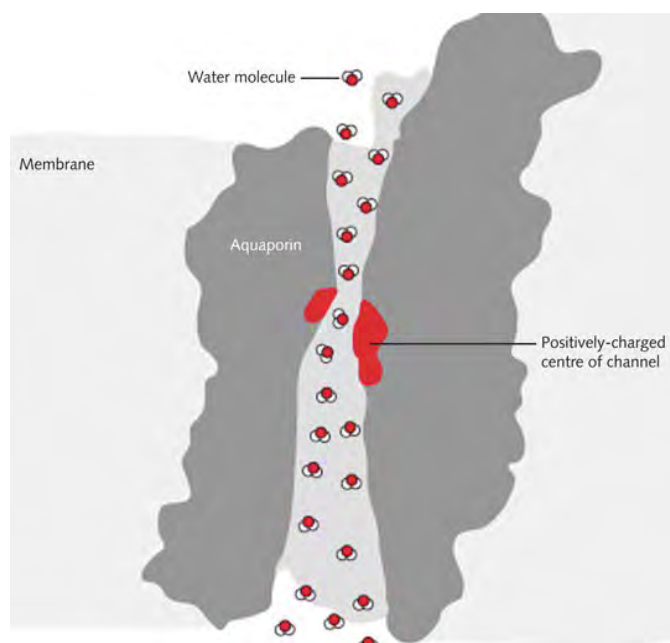
**Figure 22: Diagram of the CDI desalination cell Using nanoparticles (Jeon et al. 2013).**

In Figure 22 there is a anion membrane (red) and a cation membrane (green) separating the central flow of water from the electrodes (black). The membranes are supported by spacers allowing a flow of concentrate containing the carbon nanoparticles (the black dots) acting as secondary electrodes. The central section contains the water which is desalinated as it flows through the section.

## Review of Current Knowledge

### *Biomimetic membranes.*

Membrane technology has changed considerably over the past 60 years or so when ion-exchange membranes and then RO membranes were first developed. State-of-the-art synthetic membranes at optimal conditions can now desalinate sea water with an energy demand about 15–20% of that used for the early RO membranes. However this is still 1.5 to 2.0 times the minimum energy of the theoretical thermodynamic levels. There is therefore continuing research to develop new membranes with improved performance to provide better separations and lower energy demands (Tang et al., 2012). In 2006 it was suggested that biological membranes might provide possibilities for the development of new membranes (Bowen, 2006). The idea behind biomimetic membranes is to use or mimic the chemistry found in nature to facilitate water transport through the membrane so that it effectively acts as a fine sieve. In this case, the contaminants rejected would be much smaller than fine particle size and would be dissolved in water. However, the pores would be small enough and have the appropriate charge properties to reject these species, but still facilitate the transport of water across the membrane barrier without the resistance intrinsic to the RO process. The molecules used in nature to facilitate water transport through cell walls are proteins known as aquaporins. The aquaporins form fine ‘channels’ across the separating layer of the membrane, but the mechanism by which ionic species are rejected and retained on the feed side are electrostatic repulsion rather than size exclusion. The highly permeable channels have a low resistance to the passage of water molecules, while the ionic species are selectively rejected. This is illustrated in Figure 23 (Pearce, 2012).



**Figure 23: Diagram showing how the aquaporin membrane works (Pearce, 2012).**

## Review of Current Knowledge

---

Biomimetic membranes are still a matter for research and it will be a few years before they can be applied in commercial plant. Microbial desalination is an even newer technology which may offer benefits in the future but which is still in the laboratory stage (El Mekawy et al. 2014).

### **8 What is the cost of water produced by desalination?**

Energy is key to the cost of desalination and it is not possible to give a definitive answer to this important question although the costs are made up of a number of factors as shown in Figures 24 and 25 which show that the single largest cost factor in both thermal and membrane desalination is energy which varies considerably between countries around the world.

There are also alternative sources of energy which have been proposed which will affect the costs of energy, for example linking desalination plants with wind-power. An on-shore prototype using wind-power has been operating successfully on the German Rügen Island in the North Sea since March 1995 producing a maximum of 15 m<sup>3</sup>/hr of potable water from a 300kW wind turbine (Garcia-Rodriguez, 2004). Two modular RO pilot plants were installed on the Island of Syros, Greece, in 1997 using a 500kW wind generator linked to a RO unit with 8 membranes producing between 60 and 900 m<sup>3</sup>/day of potable water, and an experimental wind-powered RO unit was installed in France as early as 1982 (Carvalho & Riffel, 2003). Desalination units powered by renewable energy have been installed on Gran Canaria, Canary Islands (Wind-RO, seawater, 5–50 m<sup>3</sup>/d), Fuerteventura Island, Spain (Wind-diesel hybrid system, seawater, 56 m<sup>3</sup>/d), and the Centre for Renewable Energy Systems Technology in the UK (Wind-RO, seawater 12 m<sup>3</sup>/d) (Isaka, 2012).

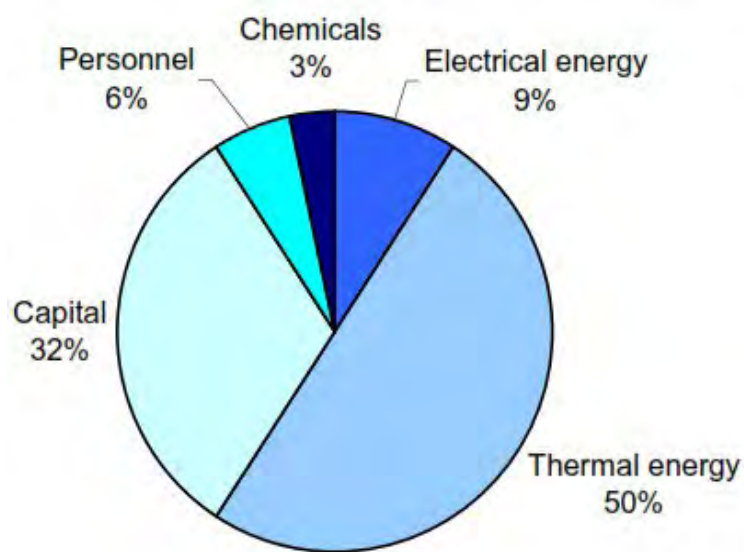
In Gulf countries most power plants are co-generation power desalting plants (CPDP) which simultaneously generate power and produce fresh water by desalination of seawater (Almulla et al. 2005). Professor Ian Fells (2005) has pointed out that combined nuclear power and desalination plants could be used to overcome the growing water shortages in the UK.

A breakdown of approximate costs for thermal and RO desalination is shown in Figures 24 and 25.

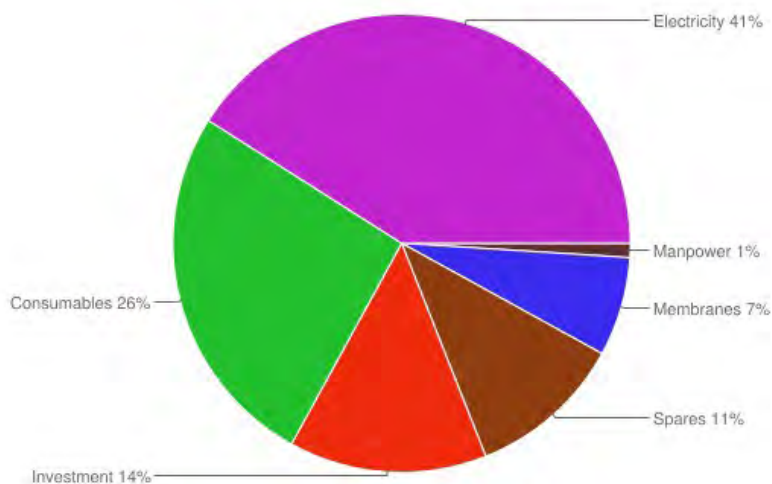
# Review of Current Knowledge

**Table 7: Thermal desalination technologies which can use energy from renewable sources. (Isaka, 2012)**

Thermal Technologies	MSF	MED	VC	RO	ED
Renewable energy	✓	✓	✓	✓	✓
Solar thermal			✓	✓	✓
Solar PV			✓	✓	✓
Wind	✓	✓	✓	✓	✓
Geothermal	✓	✓	✓	✓	✓

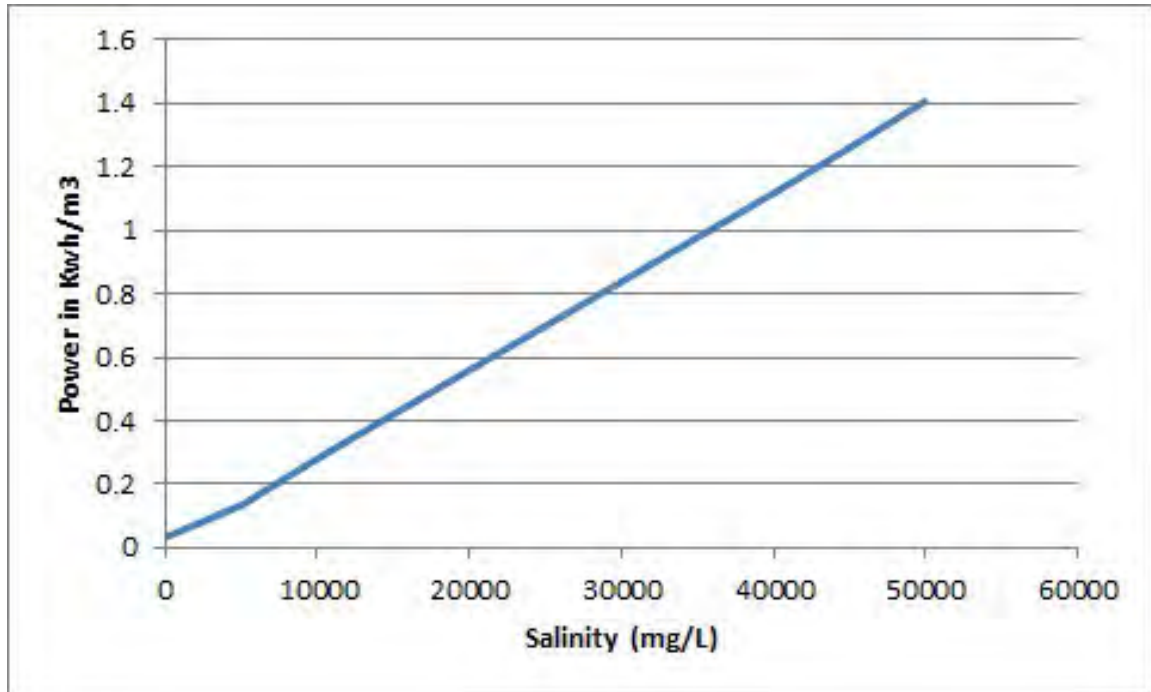


**Figure 24: Breakdown of the costs in thermal desalination (National Research Council, 2004)**



**Figure 25: Breakdown of costs for RO (Lenntech)**

## Review of Current Knowledge



**Figure 26: Graph showing the theoretical minimum power required for desalination by any technology. (Adapted from data in UNESCO, 2008)**

Table 8 below gives a summary of the range of prices for desalinated water which varies considerably depending on location, source of water and the processes used.

**Table 8: Costs of desalinated water adapted from Zotalis et al. (2014) and other sources.**

Type of Water	Plant capacity (m <sup>3</sup> /d)	Cost (£/m <sup>3</sup> )
	<20	3.24-7.43
Brackish water RO	20-1,200	0.45-0.76
	40,000-46,000	0.15-0.31
	<100	0.84-10.8
	250-1,000	0.72-2.26
Seawater RO	1,000-4,800	0.40-1.00
	15,000-60,000	0.26-0.94
	100,000-320,000	0.30-0.38
	<100	1.44-5.76
MSF	12,000-55,000	0.55-0.86
	>91,000	0.30-0.58
MED	23,000-528,000	0.30-1.01
VC	1,000-1,200	1.16-1.53

## Review of Current Knowledge

---

The cost of water in the UK is 71p to 224p per m<sup>3</sup> (Consumer Council for Water, 2015) depending, on the area of the country, the source of water, the amount of treatment and pumping required. On average, distribution accounts for 15% of costs (11p to 34p per m<sup>3</sup>) and treatment accounts for 13% of costs (OFWAT, 2002). Costs for desalinated water in different parts of the world are equally varied as shown in Table 8 depending on the source and the process used. As technology improves costs fall, although since energy accounts for 40% to 50% of the cost, the price of water is heavily dependent on energy costs. However, increasing concern for sustainability will put pressure on society to recycle and use water more efficiently than at present and it should be possible to keep down increases in the cost of water to households and industry.

### 9 Summary

Water scarcity is growing around the world including Europe and the UK. Existing water resources are already under stress, and this is getting worse. Alternative sources of fresh water are urgently required in many countries around the world. The export and transport of water between countries has only limited application; solutions to this problem include the more economical use of water, increased recycling and the desalination of brackish waters and seawater.

About 23% of the world's population lives within 100 km of the sea and population densities in coastal regions are about three times higher than the global average (Parry et al., 2007). There has been a disproportionately rapid expansion of economic activity, settlements and urban centres in coastal areas. Sixty percent of the world's 39 metropolises with populations over 5 million are located within 100 km of the coast, including 12 cities with populations more than 10 million.

This is putting extra stress on coastal areas resulting in problems such as over-exploitation of limited water resources, saline intrusion (i.e. seepage of contaminating seawater into the aquifers which supply the population) and generation of wastewater. The only answer to this growing problem is increased desalination of seawater and increased recycling requiring treatment which in turn can be achieved with desalination processes. Already some countries are well on the way to resolving their water shortages using desalination; two examples of this are Israel with over 40% of its fresh water, and Saudi Arabia with 70% of water to its cities, coming from desalination.

## **Review of Current Knowledge**

---

There is a wide range of suitable technologies available, the principal ones being variants of distillation and reverse osmosis, and both of these will continue to be used although reverse osmosis is fast becoming the preferred technology. Desalination requires power and the use of alternative methods such as the conjunctive use of power generation and wind-generators is likely to increase.

The cost of producing potable water by desalination is falling although it is still more expensive than producing potable water from conventional resources.

A number of new technologies, and techniques for improving existing technologies, are currently under investigation and within the next few years newer, cheaper and more effective methods of desalination can be expected.

# Review of Current Knowledge

---

## Bibliography

Desalination Yearbook, 2014-15. Media Analytics Ltd., Kingsmead House, Oxepens Road, Oxford, OX1 1XX. ISBN 978-1-907467-30-1

Desalination: Water from Water. ed Jane Kucera. Pub. Scrivener Publishing, 2014. ISBN 978-1-118-20852-6

Desalination Markets 2016: Global perspective and opportunities for growth. Pub. 2nd Apr 2015 by Global Water Intelligence .  
<http://www.globalwaterintel.com/>

Desalination. The International Journal on the Science and Technology of Desalting and Water Purification, pub. by Elsevier. ISSN: 0011-9164

Water Desalination Using Renewable Energy: Technology Brief  
Pub. IEA-ETSAP and IRENA. Technology Brief I12 – March 2012. Available from:  
[iea-etsap.org/web/Supply.asp](http://iea-etsap.org/web/Supply.asp)  
[www.irena.org/Publications](http://www.irena.org/Publications)

Desalination: a national perspective by the National Research Council. Committee on Advancing Desalination Technology, National Academies Press (U.S.A) 2008 ISBN (PDF) 0-309-11924-5; ISBN (Book) 0-309-11923-5.

Water Desalination. United States Army, University Press of the Pacific. Paperback Pub. March 18, 2005. ISBN 1-4102-2163-6.

Bushnak, A. A. (2010) Desalination (Chapter 8) in El-Ashry M., Saab S., Zeitoon B. Eds. *Water: Sustainable management of a scarce resource*. Pub. Arab Forum for Environment and Development (AFED). See  
<http://www.afedonline.org/Report2010/main.asp>

## Review of Current Knowledge

---

### Other useful sources of information

The European Desalination Society, Science Park of Abruzzo Via Antica Arischia, 1 - L'Aquila 67100, Italy. Tel. +39 0862 319954 Fax +39 0862 3475 213 <http://www.edsoc.com/>

The Desalination Directory, Science Park of Abruzzo Via Antica Arischia, 1 - L'Aquila 67100, Italy. <http://www.desline.com/>

International Desalination Association (IDA), POB 387, 7 Central Street, Topsfield, A 01983 USA. Tel. +1 978 887 0410 Fax. +1 978 887 0411 <http://www.idadesal.org/>

World Water Council. Espace Gaymard, 2-4 Place d'Arvieux, 13002, Marseille, France. <http://www.worldwatercouncil.org/>

# Review of Current Knowledge

---

## References

- Allredge, A. L., Passow, U. & Logan, B. E. (1993) The abundance and significance of a class of large, transparent organic particles in the ocean. *Deep-Sea Res.* 40, 1131-1140.
- Almulla, A., Hamad, A. & Gadalla, M. (2005) Integrating hybrid systems with existing thermal desalination plants. *Desalination*, 174(2), 171-192.
- Aquaver, (2014)  
<http://www.aquaver.com/inaugurated-in-the-maldives-the-first-desalination-plant-powered-by-waste-heat/>
- BBC (2000). Water wars: Part 1 - The Middle East. see website at [http://news.bbc.co.uk/1/hi/world/middle\\_east/677547.stm](http://news.bbc.co.uk/1/hi/world/middle_east/677547.stm)
- Berman, T. & Holenberg, M. (2005). Don't fall foul of biofilm through high TEP levels. *Filtration & Separation*, May. 30-32.
- Blanco, J., Alarcón, D., Gernjak, W., Guillén, E., Farré, M.J. and Malato, S. (2008) Solar desalination - Recent research activities of Plataforma Solar de Almeria. In the conference Atelier Mediterranéen sur les nouvelles technologies de recyclage des eaux, 28 Apr - 1 May 2008, Agadir, Morocco.
- Bowen, W. R. (2006) Biomimetic separations — learning from the early development of biological membranes, *Desalination*, 199, 225–227.
- Camacho, L. M., Dumée, L., Zhang, J., Li, J-d., Gomez, J., Duke, M., and Gray, S. (2013). Advances in Membrane Distillation for Water Desalination and Purification Applications: A review. *Water*, 5, 94-196; doi:10.3390/w5010094
- Carvalho, P. C. M. & Riffel, D. B. (2003) Analysis of the Use of Wind Powered Reverse Osmosis Sea Water Desalination Plants in the Northeast Region, Brazil. RIO 3 - World Climate & Energy Event, 1-5 December 2003, Rio de Janeiro, Brazil 287.
- Consumer Council for Water (2015) Water Meter Calculator for 2014-15. <http://www.ccwater.org.uk/watermetercalculator/>
- Corfield, R. (2002) Close encounters with crystalline gas. *Chemistry in Britain*, 38, Part 5, 22-25.

## Review of Current Knowledge

---

Corum, L., 2014 (May), Australia's Drought Ends As California's Begins. *Water Efficiency Journal*  
<http://www.waterefficiency.net/WE/Articles/25723.aspx>

Crow, J. M. (2012) Keeping the tap on. *Chemistry World* , 9(2).

Dabbagh, T., Sadler, P., Al-Saqabi, A., and Sadeqi, M. (1994). Water in the Arab World. Desalination; An Emergent Option. 203-241. (cited in Sourcebook of Alternative Technologies for Freshwater Augmentation in West Asia, Technical Publication, No.8f, pub. UNEP, 2002. ISBN: 9280718118)

Defra (2000) Waterways for Tomorrow - Department for Environment, Food & Rural Affairs.  
<http://webarchive.nationalarchives.gov.uk/20100104171600/http://www.defra.gov.uk/rural/documents/countryside/waterways/waterways-for-tomorrow.pdf>

Ehrenman, G. (2004) From sea to sink: with supplies of water under stress, the prospect of rendering saltwater drinkable is growing more appealing and more affordable. *Mechanical Engineering Magazine*, New York, 126, 38-43.

Ellis, C. (2003) Hot mist strips salt from the sea. *New Scientist*, issue 2403.

El Mekawy, A., Hegab, H. M. and Pant, D. (2014) The near-future integration of microbial desalination cells with reverse osmosis technology. *Energy Environ. Sci.*, 7, 3921-3933

Environment Agency and Natural Resources Wales (2013) Water stressed areas – final classification.

European Environment Agency (2003) Indicator Fact Sheet (WQ01c) Water exploitation index.

European Environment Agency (2009) Water resources across Europe confronting water scarcity and drought. EEA Report No 2/2009

## Review of Current Knowledge

---

European Environment Agency (2010) The European environment - state and outlook 2010. Water resources: quantity and flows.

<http://www.eea.europa.eu/soer/europe/water-resources-quantity-and-flows>

Fells, I. (2005) Energy Solutions. letter in *The Times*, 14th June 2005.

Food and Agriculture Organization & World Water Council (2015) Towards a Water and Food Secure Future: Critical Perspectives for Policy-makers.

Ganiaris, N., Lambiris, J., Glasser, R., Hunter, J. A., Rinne, W. W. & Verikios, S. C. (1969) Secondary Refrigerant Freezing Desalting Process: Operation of a 15,000 GPD Pilot Plant. [Washington D.C]. UNT Digital Library.

<http://digital.library.unt.edu/ark:/67531/metadc38804/>

Garcia-Rodriguez, L. (2004) Desalination by Wind Power. *Wind Engineering*, 28(4), 453-463.

Haaretz (2014) 24th Jan. Over and drought: Why the end of Israel's water shortage is a secret. <http://www.haaretz.com/news/national/1.570374>

Hoekstra, A. Y. and Chapagain, A. K. (2008) Globalization of Water: Sharing the Planet's Freshwater Resources, Blackwell Publishing, Oxford.

IDA (International Desalination Association) (2014) The IDA Desalination Yearbook, 2014-2015.

Isaka, M. (2012) Water Desalination Using Renewable Energy: *Technology Brief. IEA-ETSAP and IRENA Technology Brief I12* .

Jeon, S-i., Park, H-r., Yeo, J-g., Yang, S. C., Cho, C. H., Han, M. H. and Kim, D. K. (2013) Desalination via a new membrane capacitive deionization process utilizing flow-electrodes. *Energy Environ. Sci.*, 6, 1471-1475. DOI: 10.1039/C3EE24443A

Johnson, M. A. & Polyakov, I. V., (2001) The Laptev Sea as a source for recent Arctic Ocean salinity changes, *Geophys. Res. Lett.*, 28, 2017-2020. see website <http://onlinelibrary.wiley.com/doi/10.1029/2000GL012740/pdf>

## Review of Current Knowledge

---

Krebs, J. (2012) Climate change – is the UK preparing for flooding and water scarcity? Adaptation Sub-Committee Progress Report.

Lee, H-J., Moon, S-H. (2014) Electrodialysis Desalination. Desalination: Water from Water. Ed. Kucera, J. Scrivener Publishing. ISBN 978-1-118-20852-6

Lenntech

<http://www.lenntech.com/processes/desalination/energy/general/desalinationcosts.htm>

Locke Bogart, S. & Schultz, K. (2004) Water Desalination as a Possible Opportunity for the GT- and H2-MHR. .See:  
<https://www.researchgate.net/publication/266033143>

Max, M. D. (2005) Testimony before the Committee on Resources, United States House of Representatives, May 2005.  
<http://web.archive.org/web/20051228042203/http://resourcescommittee.house.gov/archives/109/testimony/2005/michaelmax.htm>

Max, M.D. (2009) Apparatus for hydrate-based desalination using compound permeable restrain panels and vaporization-based cooling. US Patent 7,845,222 B2. Filed 8 May 2007, issued 3 Feb 2009, 51pp.

McCormack, R.A. & Andersen, R.K. Clathrate desalination plant preliminary research study, U.S. Dept. of the Interior, Bureau of Reclamation, Water Treatment Technology Program Report 5, June 1995.

McCutcheon, J.R., McGinnisb, R.L. & Elimelecha, M. (2005) A novel ammonia-carbon dioxide forward (direct) osmosis desalination process. *Desalination* 174, pages 1–11.

McCutcheon, J.R. & Bui, N-N. (2014) Forward Osmosis. Desalination: Water from Water, pub. Scrivener, ISBN 978-1-118-20852-6

McLoughlin, P. (2004) Scientists Say Risk of Water Wars Rising. Reuters' Report on the World Water Week conference in Stockholm, August 2004.

National Research Council, (2004) Review of the desalination and water purification roadmap. pub. National Academy of Sciences, ISBN 0-309-09157-8. see also the website at:  
<http://www.nap.edu/catalog/10912.html>

## Review of Current Knowledge

---

National Research Council (2008) Desalination: A National Perspective. The Committee on Advancing Desalination Technology. ISBN-10: 0-309-11923-5. See also the website at:

[http://www.nap.edu/openbook.php?record\\_id=12184&page=7](http://www.nap.edu/openbook.php?record_id=12184&page=7)

New York Times (2015) 1st April, California Imposes First Mandatory Water Restrictions to Deal With Drought.

OFWAT (2002) International comparison of water and sewerage service; 2000-01 report.

<http://discovery.nationalarchives.gov.uk/details/record?catid=8311060&catln=6>

Palmer, N. (2014) Why we need seawater desalination plants. Opinion piece. National Centre of Excellence in Desalination Australia.

<http://desalination.edu.au/2014/10/why-we-need-seawater-desalination-plants/#.VUd395PcAXg>

Parkinson, G. (2015)

<http://reneweconomy.com.au/2015/saudis-build-worlds-first-large-scale-solar-powered-desalination-plant-82903>

Parry, M. L., Canziani, O. F., Palutikof, J. P., van der Linden, P. J., and Hanson, C. E. (eds) (2007) IPCC Fourth Assessment Report: Climate Change 2007. Chapter 6: Coastal Systems and Low-Lying Areas. 6.2.2 Increasing human utilisation of the coastal zone. Contribution of Working Group II to the Fourth Assessment Report of the Intergovernmental Panel on Climate Change. Cambridge University Press.

Pearce, G. K. (2012) Biomimetic Membranes: Taking on Energy Usage in Water Purification. *Water World* Vol. 27 Issue 3.

Qu, W. (2009) Report for Project 2008HI231B: "Experimental Study of Humidification-Dehumidification (HDH) Seawater Desalination Driven by Solar Energy". <http://water.usgs.gov/wrri/08grants/2008HI231B.html>

Rahman, M., Al-Khusaibi, M. (2014) Freeze-melting desalination process. Desalination: Water from Water. Ed. Kucera, J. Scrivener Publishing. ISBN 978-1-118-20852-6

Schippers, J. C. (1979) Progress in desalination. *Physics in Technology* 10 252-258.

## Review of Current Knowledge

---

Seckler, D., Upali A., Molden D., de Silva, R., and Barker, R. (1998) World water demand and supply, 1990 to 2025: Scenarios and issues. Research Report 19. International Water Management Institute.

Talbot, D. (2015) The world's largest and cheapest reverse-osmosis desalination plant is up and running in Israel. *MIT Technology Review*, 18 Feb 2015.

Tang, C. Y., Zhao, Y., Wang, R., Hélix-Nielsen, C., & Fane, A. G. (2012). Desalination by biomimetic aquaporin membranes: Review of status and prospects. *Desalination*. doi: 10.1016

Thames Water (2014) Section 4: Current and future water supply. Final Water Resources Management Plan 2015-2040: Main Report.

Torchia-Núñez, J. C., Cervantes-de-Gortari, J. & Porta-Gándara, M. A. (2014) Thermodynamics of a Shallow Solar Still. *Energy and Power Engineering*, 6, 246-265 doi.org/10.4236/epe.2014.69022

UKAEA (1967) Desalination and its role in water supply. pub. HMSO for the British Information Services.

UNEP (1998) Source book of alternative technologies for freshwater augmentation in small island developing states. Technical publication series - UNEP No. 8E.

UNEP (2012) [http://na.unep.net/geas/newsletter/images/Jan\\_12/Figure1.png](http://na.unep.net/geas/newsletter/images/Jan_12/Figure1.png)

UNESCO (2003) The UN World Water Development Report, Water for People, Water for Life. (English Edition). Paris, New York and Oxford, UNESCO (United Nations Educational, Scientific and Cultural Organization) and Berghahn Books. ISBN 92-3-103881-8

UNESCO (2008) Centre for Membrane Science and Technology, University of New South Wales. Waterlines Report Series No. 9.

United States Government Accountability Office (2014) Report to Congressional Requesters Supply Concerns Continue, and Uncertainties Complicate Planning.

## Review of Current Knowledge

---

URS Australia (2002) Summary Report: Introduction to desalination in Technologies in Australia. A report prepared for Agriculture, Fisheries & Forestry - Australia.

<http://catalogue.nla.gov.au/Record/3967107>

Vaknin, S. (2005) The Emerging Water Wars. Global Politician,

<http://www.progress.org/archive/who-owns-the-worlds-water>

Water Resources Board (1972) Report: Desalination 1972.

pub. HMSO, ISBN 0117800104

WBCSD (World Business Council for Sustainable Development) (2005). Facts and Trends: Water. ISBN 2-940240-70-1

WHO (1984) Guidelines for Drinking Water Quality. pub. World Health Organisation, Geneva. ISBN 92-4-154169-5

WHO (2006) Total dissolved solids in drinking water.

WHO/SDE/WSH/03.04/16

Williams, A. (2013) Solar Powered Water Desalination Heats Up in Chile.

*WaterWorld* Vol. 28, Issue 3.

Winter, T., Pannell, D. J. & McCann, L. (2000) The economics of desalination and its potential application in Australia. SEA Working Paper 01/02,

Agricultural and Resource Economics, University of Western Australia.

see also on the website at <http://dpannell.fnas.uwa.edu.au/dpap0102.htm>

Yang, X., Fane, A. G. & Wang, R. (2014). Membrane distillation: Now and

future. *Desalination: Water from Water*, pub. Scrivener, ISBN 978-1-118-

20852-6

Zotalis, K., Dialynas E. G., Mamassis N. and Angelakis, A. N. (2014). Review:

Desalination Technologies: Hellenic Experience. *Water*, 6(5), 1134-1150;

doi:10.3390